

JVC



AUDIO/VIDEO CONTROL RECEIVER

RX-5030VBK

AV COMPU LINK

COMPU LINK
/// Remote ///

DIGITAL
dts
SURROUND

DD DOLBY
DIGITAL
PRO LOGIC II

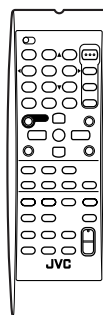
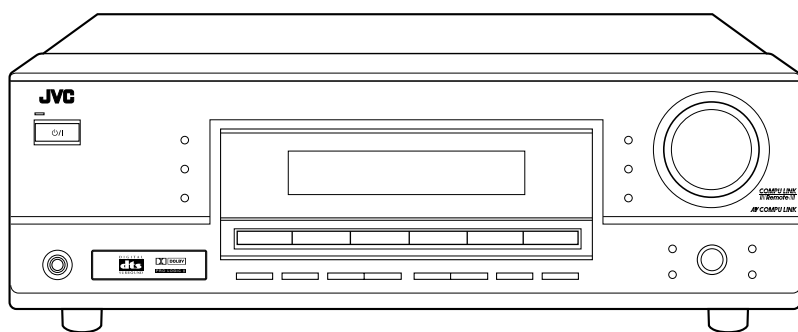

INSTRUCTIONS

For Customer Use:

Enter below the Model No. and Serial No. which are located either on the rear, bottom or side of the cabinet. Retain this information for future reference.

Model No. _____

Serial No. _____

LVT0984-011A
[UJ]

Warnings, Cautions, and Others

Caution — STANDBY/ON \odot /I switch!

Disconnect the mains plug to shut the power off completely. The STANDBY/ON \odot /I switch in any position does not disconnect the mains line. The power can be remote controlled.

CAUTION

To reduce the risk of electrical shocks, fire, etc.:

1. Do not remove screws, covers or cabinet.
2. Do not expose this appliance to rain or moisture.

CAUTION

- Do not block the ventilation openings or holes.
(If the ventilation openings or holes are blocked by a newspaper or cloth, etc., the heat may not be able to get out.)
- Do not place any naked flame sources, such as lighted candles, on the apparatus.
- When discarding batteries, environmental problems must be considered and local rules or laws governing the disposal of these batteries must be followed strictly.
- Do not expose this apparatus to rain, moisture, dripping or splashing and that no objects filled with liquids, such as vases, shall be placed on the apparatus.

Caution: Proper Ventilation

To avoid risk of electric shock and fire and to protect from damage.

Locate the apparatus as follows:

Front: No obstructions open spacing.

Sides: No obstructions in 10 cm from the sides.

Top: No obstructions in 10 cm from the top.

Back: No obstructions in 15 cm from the back.

Bottom: No obstructions, place on the level surface.

In addition, maintain the best possible air circulation as illustrated.

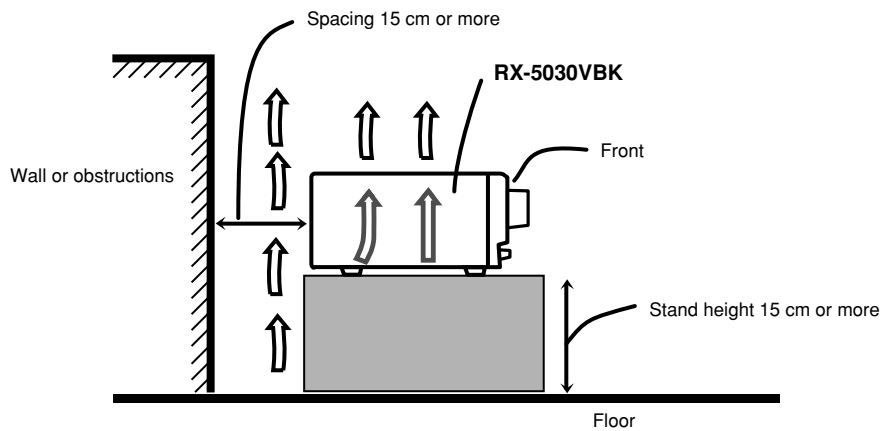

Before Installation

Precautions

General precautions

- DO NOT insert any metal object into the unit.
- DO NOT disassemble the unit or remove screws, covers, or cabinet.
- DO NOT expose the unit to rain or moisture.

Locations

- Install the unit in a location that is level and protected from moisture.
- The temperature around the unit must be between -5°C and 35°C .
- Make sure there is good ventilation around the unit. Poor ventilation could cause overheating and damage the unit.

Handling the unit

- DO NOT touch the power cord with wet hands.
- DO NOT pull on the power cord to unplug the cord. When unplugging the cord, always grasp the plug so as not to damage the cord.
- Keep the power cord away from the connecting cords and the antenna. The power cord may cause noise or screen interference. Coaxial cable is recommended for the antenna connection, since such cable is well-shielded against interference.
- When a power failure occurs, or when you unplug the power cord, the preset settings such as preset FM or AM channels and sound adjustments may be erased within a few days.

Checking the Supplied Accessories

Check to be sure you have all of the following supplied accessories. The number in parentheses indicates the quantity of each piece supplied.

- Remote control (1)
- Batteries (2)
- AM loop antenna (1)
- FM antenna (1)
- AC Plug Adaptor (1)

If anything is missing, contact your dealer immediately.

Setting the Voltage Selector Switch

Before connections, always do the following first if necessary.

Select the correct voltage in VOLTAGE SELECTOR on the rear by using a screw driver. Check to be sure if the voltage mark is set to the voltage for your area where this unit plugs in.

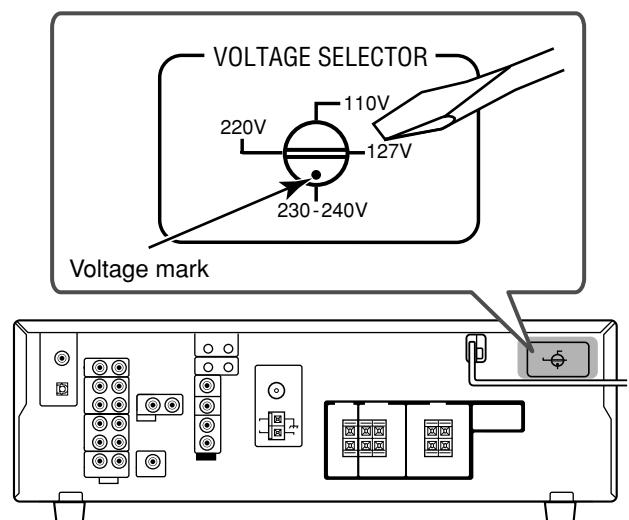

This mark indicates that ONLY the remote control CAN be used for the operation explained.



This mark indicates that the remote control CANNOT be used for the operation explained. Use the buttons on the front panel.

Table of Contents

Parts Identification	3	Tuner Operations	20
Getting Started	5	Setting the AM Tuner Interval Spacing	20
Connecting the AM and FM Antennas	5	Tuning in to Stations Manually	20
Connecting the Speakers and Subwoofer	6	Using Preset Tuning	20
Connecting Audio/Video Components	7	Storing the Preset Stations	20
Analog Connections	7	Tuning in to a Preset Station	21
Digital Connections	9	Selecting the FM Reception Mode	21
Connecting the Power Cord	9	Creating Realistic Sound Fields	22
Putting Batteries in the Remote Control	9	Using Surround Modes	24
Basic Operations	10	Using DSP Modes	25
Turning On the Power	10	COMPU LINK Remote Control System	26
Selecting the Source to Play	10	AV COMPU LINK Remote Control System	27
Changing the Source Name	10	Operating JVC's Audio/Video	
Selecting Different Sources for Picture and Sound	11	Components	29
Adjusting the Volume	11	Operating Audio Components	29
Listening with Headphones Only	11	Operating Video Components	31
Turning Off the Sound Temporarily—Muting	12	Operating Other Manufacturers' Video	
Changing the Display Brightness—DIMMER	12	Equipment	32
Turning Off the Power with the Sleep Timer	12	Troubleshooting	34
Basic Settings	13	Specifications	35
Basic Settings Using MULTI JOG Dial	13		
Setting the Speaker Information	13		
Selecting the Digital Input Terminals—DIGITAL IN	14		
Selecting the Analog or Digital Input Mode	15		
Sound Adjustments	16		
Attenuating the Input Signal	16		
Turning Off the Subwoofer	16		
Sound Adjustments Using MULTI JOG Dial	17		
Sound Adjustments Using Remote Control	18		
Adjusting Speaker Output Levels Using Test Tone	18		
Adjusting Subwoofer Output Level	19		

Parts Identification

Front Panel

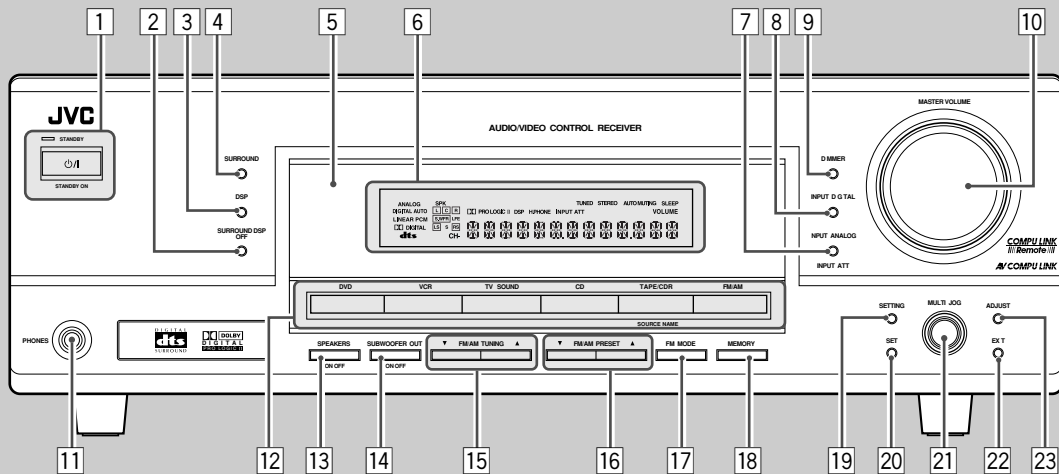

See pages in parentheses for details.

- 1 STANDBY/ON ϕ /I button and STANDBY lamp (10, 20)
- 2 SURROUND/DSP OFF button (24, 25)
- 3 DSP button (25)
- 4 SURROUND button (24)
- 5 Remote sensor (9)
- 6 Display (For details, see "Display" below.)
- 7 • INPUT ANALOG button (15)
• INPUT ATT (attenuator) button (16)
- 8 INPUT DIGITAL button (15)
- 9 DIMMER button (12)
- 10 MASTER VOLUME control (11)
- 11 PHONES jack (11)

- 12 • Source selection buttons (10)
DVD, VCR, TV SOUND, CD, TAPE/CDR, FM/AM
• SOURCE NAME button (10)
- 13 SPEAKERS ON/OFF button (11)
- 14 SUBWOOFER OUT ON/OFF button (16)
- 15 FM/AM TUNING \blacktriangle / \blacktriangledown buttons (20)
- 16 FM/AM PRESET \blacktriangle / \blacktriangledown buttons (20, 21)
- 17 FM MODE button (21)
- 18 MEMORY button (20, 21)
- 19 SETTING button (13)
- 20 SET button (13, 17)
- 21 MULTI JOG dial (13, 17)
- 22 EXIT button (13, 17)
- 23 ADJUST button (17)

Display

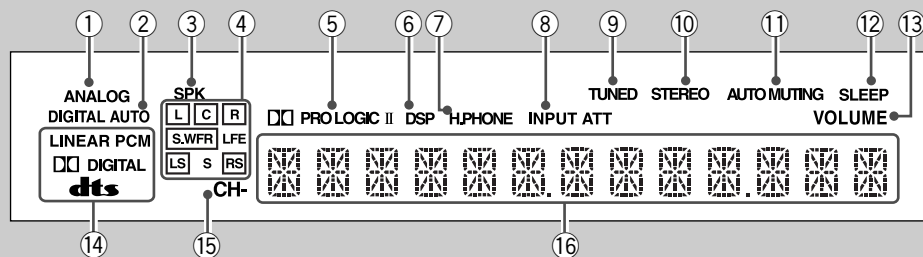

See pages in parentheses for details.

- 1 ANALOG indicator (15)
- 2 DIGITAL AUTO indicator (15)
- 3 SPK (speaker) indicator (11)
- 4 Speaker indicators and signal indicators (25)
- 5 $\square\square$ PRO LOGIC II indicator (22, 24)
- 6 DSP indicator (23, 25)
- 7 H.PHONE indicator (11)
- 8 INPUT ATT (attenuator) indicator (16)
- 9 TUNED indicator (20)
- 10 STEREO indicator (20)
- 11 AUTO MUTING indicator (21)
- 12 SLEEP indicator (12)
- 13 VOLUME indicator (12)
- 14 Digital signal format indicators (15)
- 15 CH- indicator (20)
- 16 Main display

Remote Control

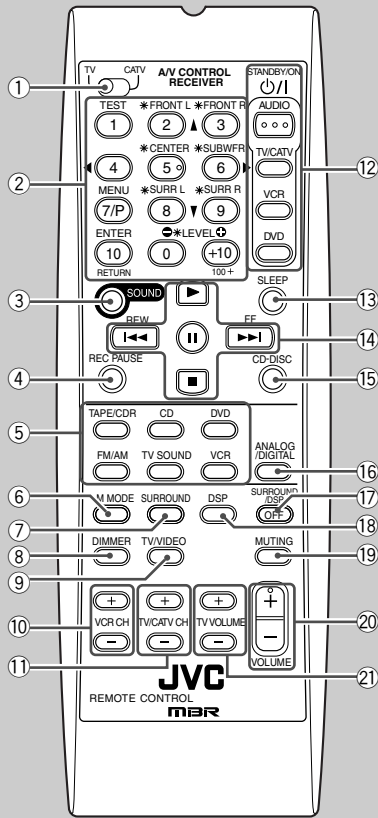

See pages in parentheses for details.

- ① TV/CATV selector (32)
- ② • 10 keys for selecting preset channels (21)
• 10 keys for sound adjustment (18, 19)
• 10 keys for operating audio/video components (29 – 33)
- ③ SOUND button (18, 19)
- ④ REC PAUSE button (30, 31, 33)
- ⑤ Source selection buttons (10)
TAPE/CDR, CD, DVD, FM/AM, TV SOUND, VCR
- ⑥ FM MODE button (21)
- ⑦ SURROUND button (24)
- ⑧ DIMMER button (12)
- ⑨ TV/VIDEO button (31)
- ⑩ VCR CH (channel) +/- buttons (31, 33)
- ⑪ TV/CATV CH (channel) +/- buttons (31, 32)
- ⑫ STANDBY/ON ϕ /I buttons (10, 31 – 33)
AUDIO, TV/CATV, VCR, DVD
- ⑬ SLEEP button (12)
- ⑭ Operating buttons for audio/video components
▶, II, ■, ►/◄, FF/REW (30, 31, 33)
- ⑮ CD-DISC button (30)
- ⑯ ANALOG/DIGITAL button (15)
- ⑰ SURROUND/DSP OFF button (24, 25)
- ⑱ DSP button (25)
- ⑲ MUTING button (12)
- ⑳ VOLUME +/- button (11)
- ㉑ TV VOLUME +/- buttons (31)

Rear Panel

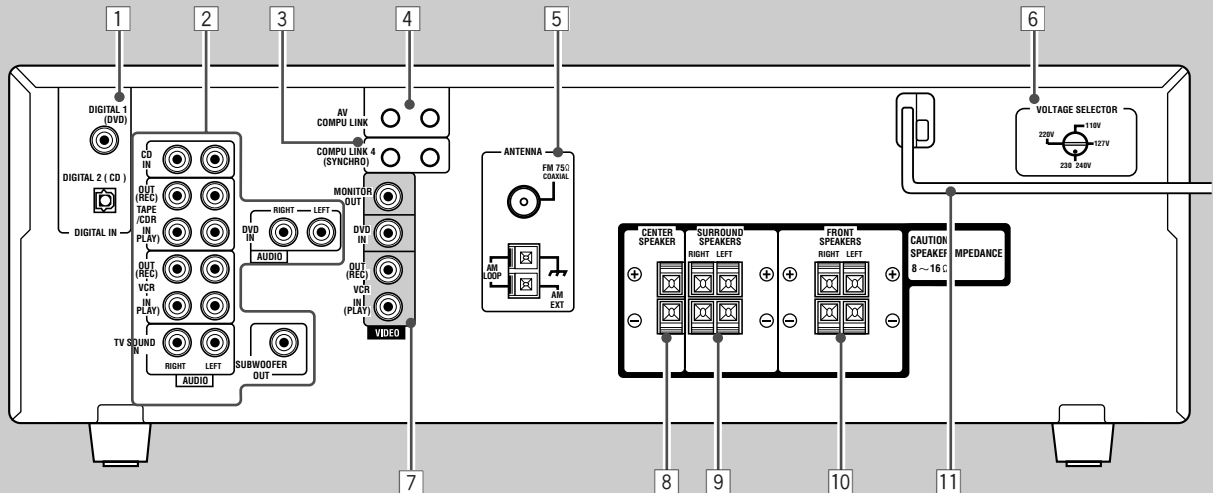

See pages in parentheses for details.

- ① DIGITAL IN terminals (9)
• Coaxial: DIGITAL 1 (DVD)
• Optical: DIGITAL 2 (CD)
- ② Audio input/output terminals (6 – 8)
• Input: CD IN, TAPE/CDR IN, VCR IN, TV SOUND IN, DVD IN
• Output: TAPE/CDR OUT, VCR OUT
• SUBWOOFER OUT
- ③ COMPU LINK-4 (SYNCHRO) terminals (26)
- ④ AV COMPU LINK terminals (27)
- ⑤ FM/AM ANTENNA terminals (5)
- ⑥ Voltage selector (1)
- ⑦ VIDEO (composite video) input/output terminals (8)
• Input: DVD IN, VCR IN
• Output: MONITOR OUT, VCR OUT
- ⑧ CENTER SPEAKER terminals (6)
- ⑨ SURROUND SPEAKERS terminals (6)
- ⑩ FRONT SPEAKERS terminals (6)
- ⑪ AC power cord (9)

Getting Started

Connecting the AM and FM Antennas

AM antenna connection

Connect the supplied AM loop antenna to the AM LOOP terminals.

Turn the loop until you have the best reception.

- If the reception is poor, connect an outdoor single vinyl-covered wire (not supplied) to the AM EXT terminal. (Keep the AM loop antenna connected.)

FM antenna connection

Connect the supplied FM antenna to the FM 75 Ω COAXIAL terminal as a temporary measure.

Extend the supplied FM antenna horizontally.

- If the reception is poor, connect an outdoor FM antenna (not supplied). Before attaching a 75 Ω coaxial cable with a connector, disconnect the supplied FM antenna.

How to connect the AM antenna cord

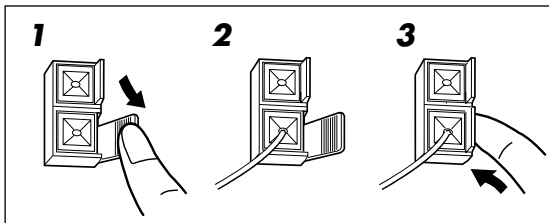

1 Open the terminal.

2 Insert the AM antenna cord.

3 Close the terminal.

Notes:

- If the AM loop antenna wire is covered with vinyl, remove the vinyl by twisting it as shown to the right.
- Make sure the antenna conductors do not touch any other terminals, connecting cords, or power cord. This could cause poor reception.



Rear panel

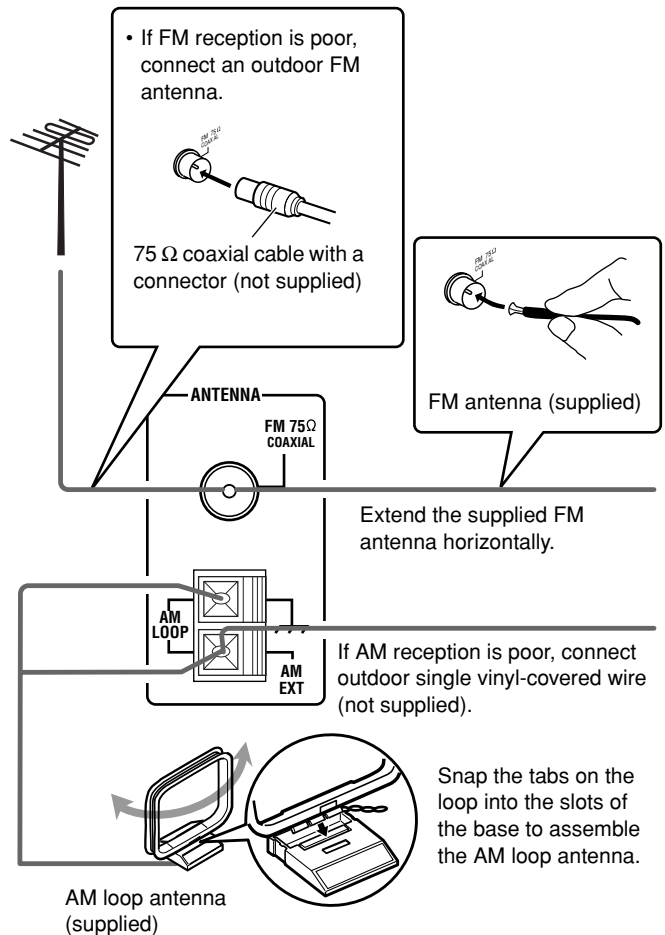
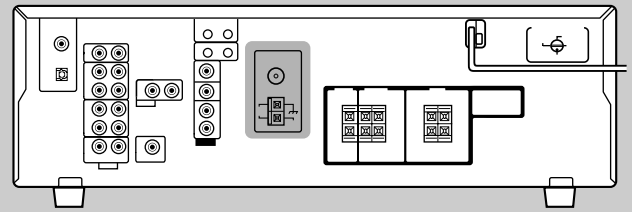

Connecting the Speakers and Subwoofer

You can connect five speakers—a pair of front speakers, a center speaker, and a pair of surround speakers—and a subwoofer.

CAUTION:

Use speakers with a **SPEAKER IMPEDANCE** as indicated by the speaker terminals.

Speaker layout diagram

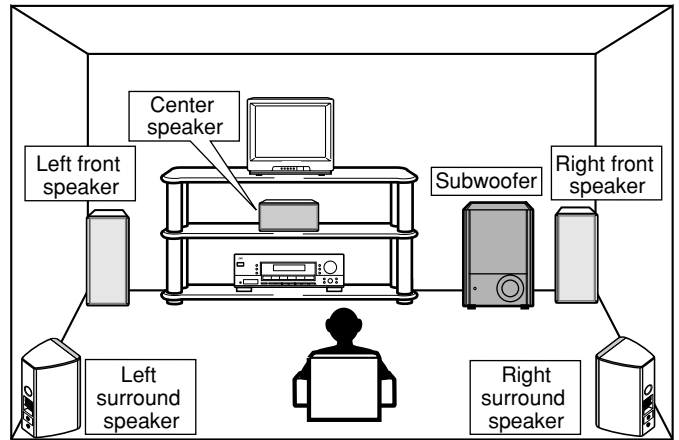

Connection diagram

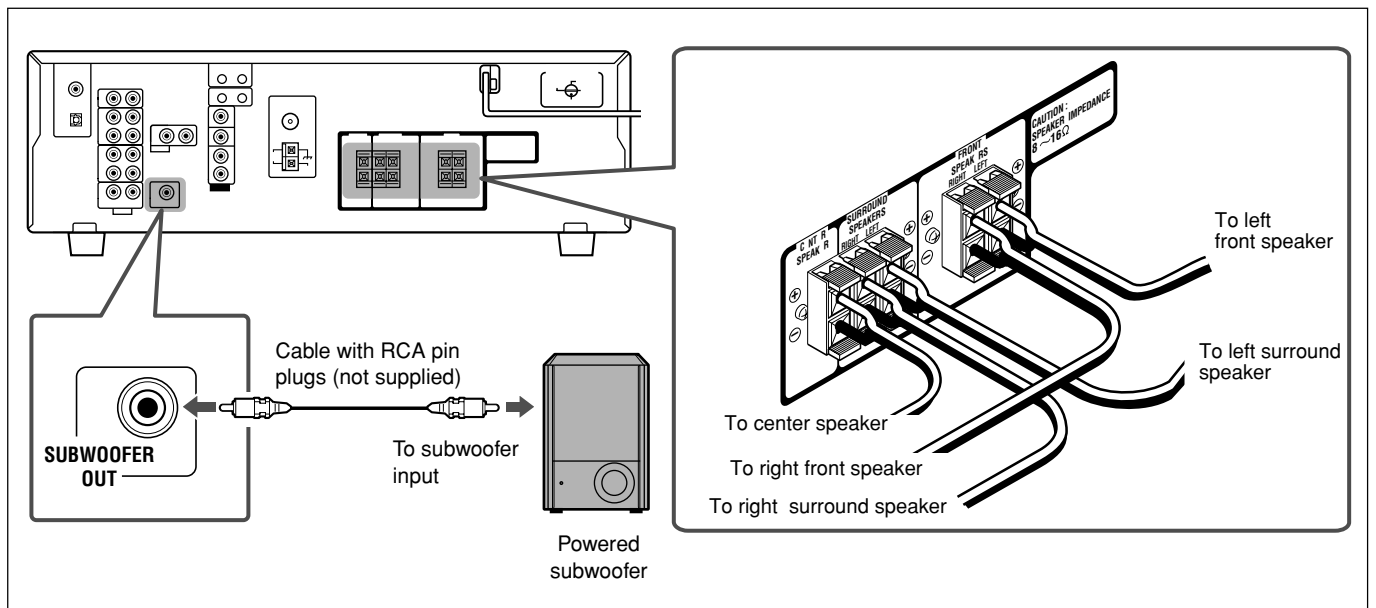

How to connect speaker cords

For each speaker, connect the (+) and (-) terminals on the rear panel to the (+) and (-) terminals marked on the speakers.

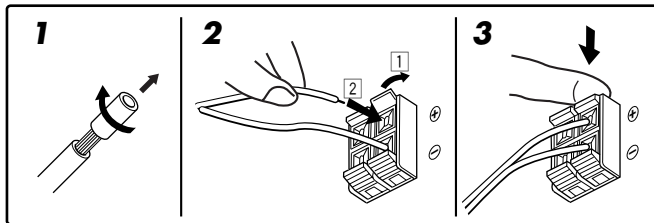

- 1** Twist and remove the insulation at the end of each speaker cord.
- 2** Open the terminal (1), then insert the speaker cord (2).
- 3** Close the terminal.

How to connect the subwoofer

Connect the input jack of a powered subwoofer to the **SUBWOOFER OUT** jack on the rear panel, using a cable with RCA pin plugs (not supplied).

- Refer also to the manual supplied with your subwoofer.

By connecting a subwoofer, you can enhance the bass or reproduce the original LFE signals recorded in the digital software.

Since bass sound is non-directional, you can place a subwoofer wherever you like. Normally place it in front of you.

After connecting the front, center, surround speakers and/or a subwoofer, set the speaker setting information properly to obtain the best possible Surround effects with your listening conditions. For details, see pages 13 and 14.

- “NO” for the subwoofer and “LARGE” for the front speakers, “SMALL” for the center and surround speakers are initial settings.

Getting Started

Connecting Audio/Video Components

Turn the power off to all components before making connections.

You can connect the following audio/video components to this receiver. Refer also to the manuals supplied with your components.

- Audio Components: CD player* and Cassette deck (or CD recorder*)
- Video Components: VCR, TV*, and DVD player*

*You can connect these components using the methods described in "Analog Connections" (below) and/or in "Digital Connections" (see page 9).

Analog Connections

Audio component connections

Use cables with RCA pin plugs (not supplied).
Connect the white plug to the audio left jack and the red plug to the audio right jack.

CAUTION:

If you connect a sound-enhancing device such as a graphic equalizer between the source components and this receiver, the sound output through this receiver may be distorted.

Rear panel

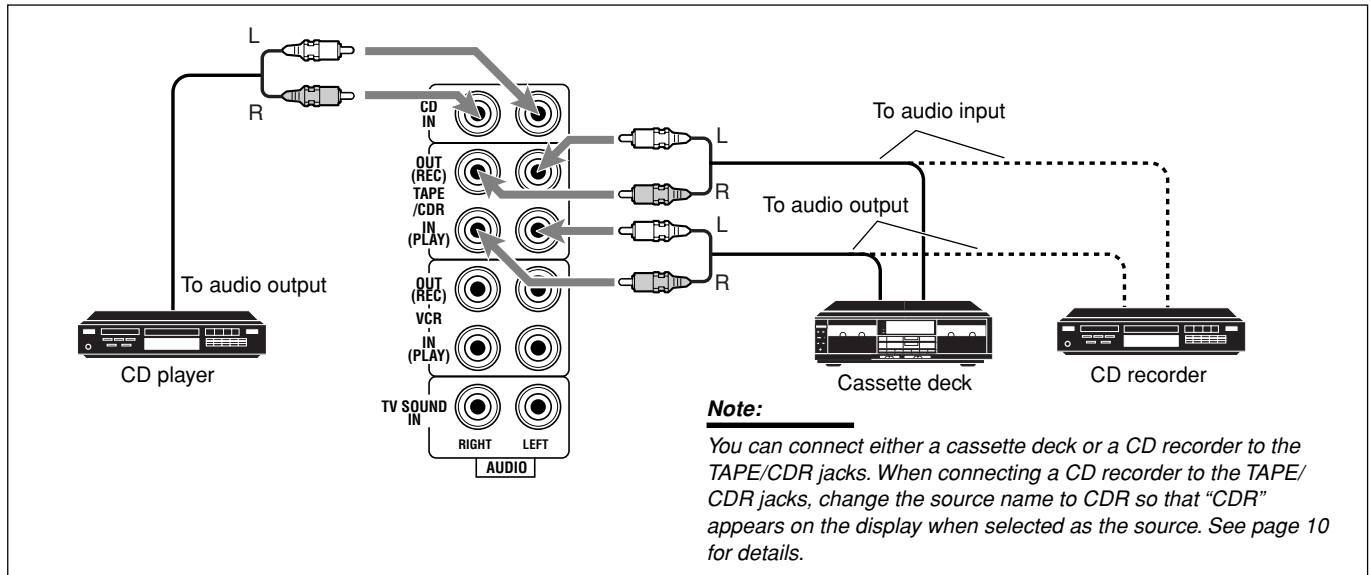
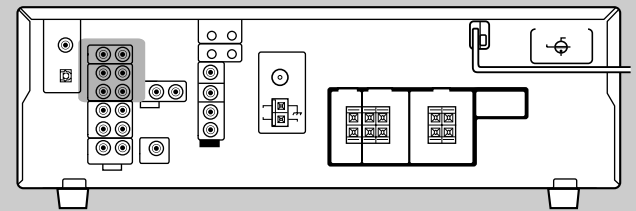

Note:

You can connect either a cassette deck or a CD recorder to the TAPE/CDR jacks. When connecting a CD recorder to the TAPE/CDR jacks, change the source name to CDR so that "CDR" appears on the display when selected as the source. See page 10 for details.

If your audio components have a COMPU LINK jack

See also page 26 for detailed information about the connections with the COMPU LINK remote control system.

Video component connections

Use cables with RCA pin plugs (not supplied).
Connect the white plug to the audio left jack, the red plug to the audio right jack, and the yellow plug to the video jack.

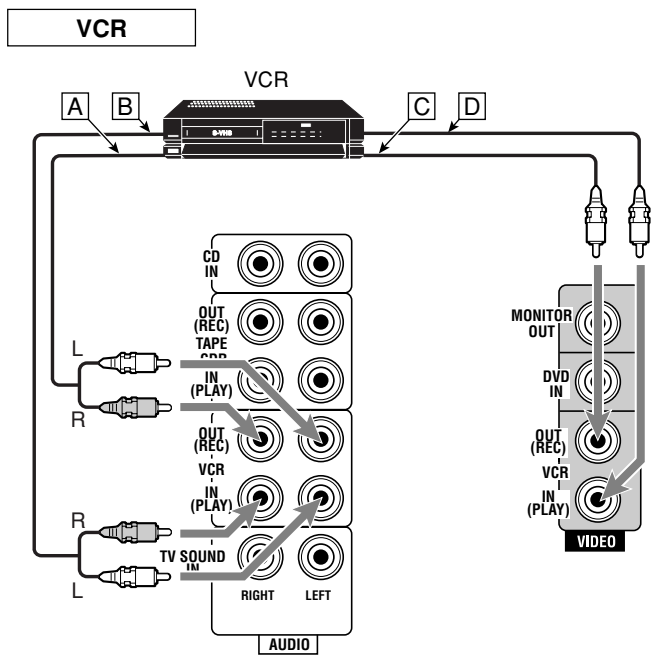
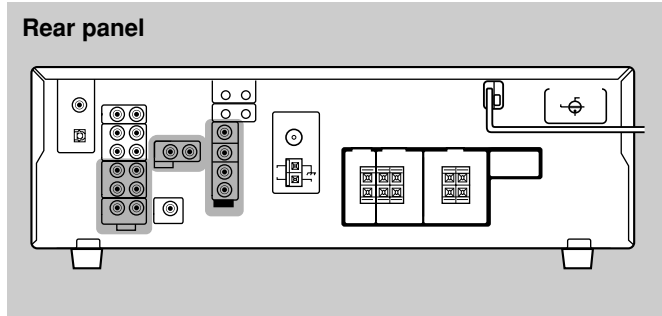

- A To left/right audio input
- B To left/right audio output
- C To video input
- D To video output

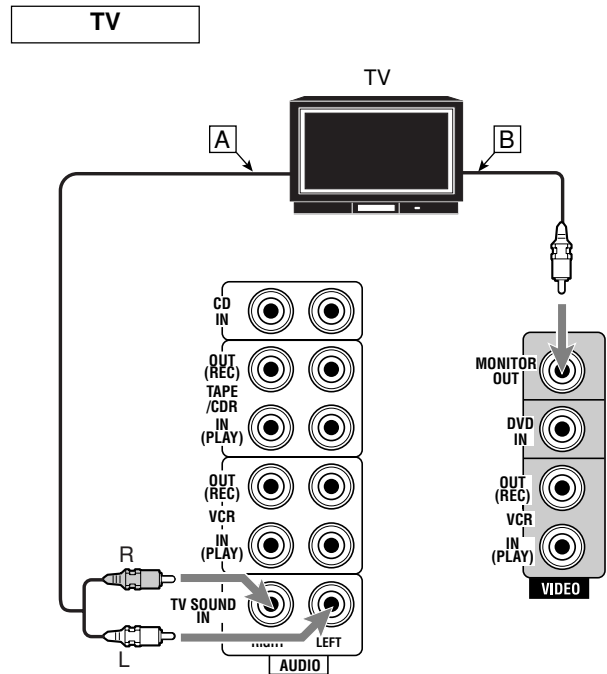

- A To audio output
- B To video input

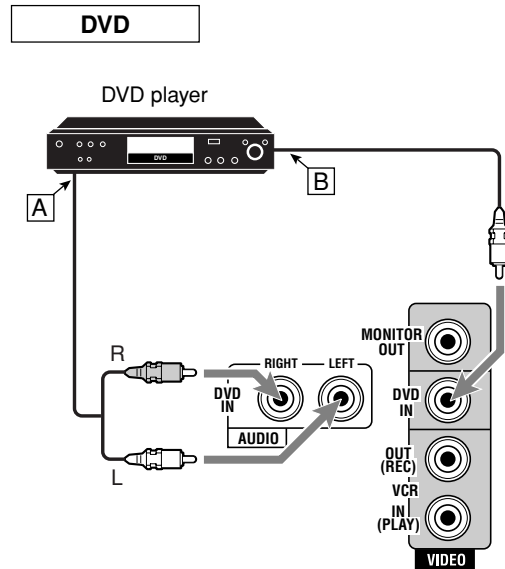

- A To audio output
- B To video output

To use software encoded with Dolby Digital or DTS Digital Surround, connect the DVD player using one of the DIGITAL IN terminals (see page 9).

Getting Started

Digital Connections

This receiver is equipped with two DIGITAL IN terminals—one digital coaxial terminal and one digital optical terminal. You can connect any component to one of the digital terminals using a digital coaxial cable (not supplied) or digital optical cable (not supplied).

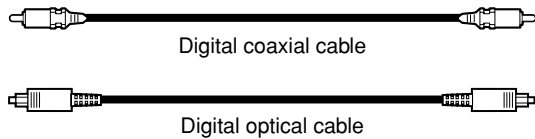

IMPORTANT:

- When connecting a video component using the digital terminal, you also need to connect it to the video jack on the rear. Without connecting it to the video jack, you cannot view the playback picture.
- After connecting the components using the DIGITAL IN terminals, correctly set the following if necessary:
 - Set the digital input (DIGITAL IN) terminal setting correctly. For details, see “Selecting the Digital Input Terminals—DIGITAL IN” on page 14.
 - Select the digital input mode correctly. For details, see “Selecting the Analog or Digital Input Mode” on page 15.

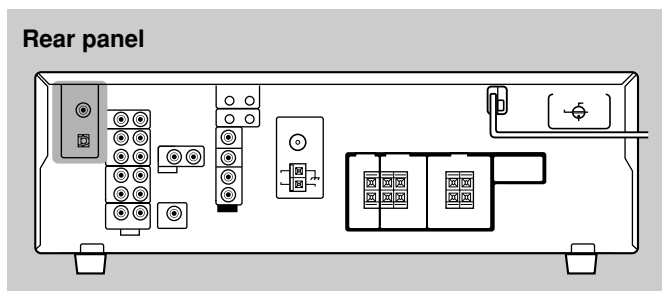

When the component has a digital coaxial output terminal, connect it to the DIGITAL 1 (DVD) terminal, using the digital coaxial cable (not supplied).

When the component has a digital optical output terminal, connect it to the DIGITAL 2 (CD) terminal, using the digital optical cable (not supplied).

Before connecting a digital optical cable, unplug the protective plug.

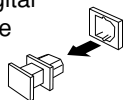

DIGITAL 1 (DVD)

DIGITAL 2 (CD)

DIGITAL IN

Notes:

- When shipped from the factory, the DIGITAL IN terminals have been set for use with the following components:
 - DIGITAL 1 (coaxial): For DVD player
 - DIGITAL 2 (optical): For CD player
- When you want to operate the CD player or CD recorder using the COMPU LINK remote control system, connect the target component also as described in “Analog Connections” (see page 7).
- When you want to operate the DVD player using the AV COMPU LINK remote control system, connect the DVD player also as described in “Analog Connections” (see page 8).

Connecting the Power Cord

Before plugging the power cord into an AC outlet, make sure that all connections have been made.

Plug the power cord into an AC outlet.

Keep the power cord away from the connecting cables and the antenna. The power cord may cause noise or screen interference. We recommend that you use a coaxial cable to connect the antenna, since it is well-shielded against interference.

CAUTIONS:

- Do not plug in before setting the voltage selector switch on the rear of the unit and all connection procedures are complete.
- Do not touch the power cord with wet hands.
- Do not pull on the power cord to unplug the cord. When unplugging the cord, always grasp the plug so as not to damage the cord.

Putting Batteries in the Remote Control

Before using the remote control, put two supplied batteries first.

- When using the remote control, aim the remote control directly at the remote sensor on the front panel.

1 On the back of the remote control, remove the battery cover.

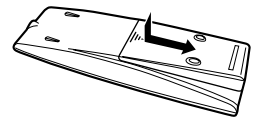

2 Insert batteries.

- Make sure to match the polarity: (+) to (+) and (–) to (–).

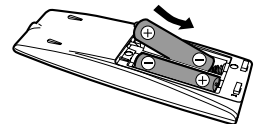

3 Replace the cover.

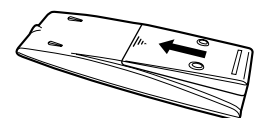

If the range or effectiveness of the remote control decreases, replace the batteries. Use two R6P(SUM-3)/AA(15F) type dry-cell batteries.

CAUTION:

Follow these precautions to avoid leaking or cracking cells:

- Place batteries in the remote control so they match the polarity: (+) to (+) and (–) to (–).
- Use the correct type of batteries. Batteries that look similar may differ in voltage.
- Always replace both batteries at the same time.
- Do not expose batteries to heat or flame.

Basic Operations

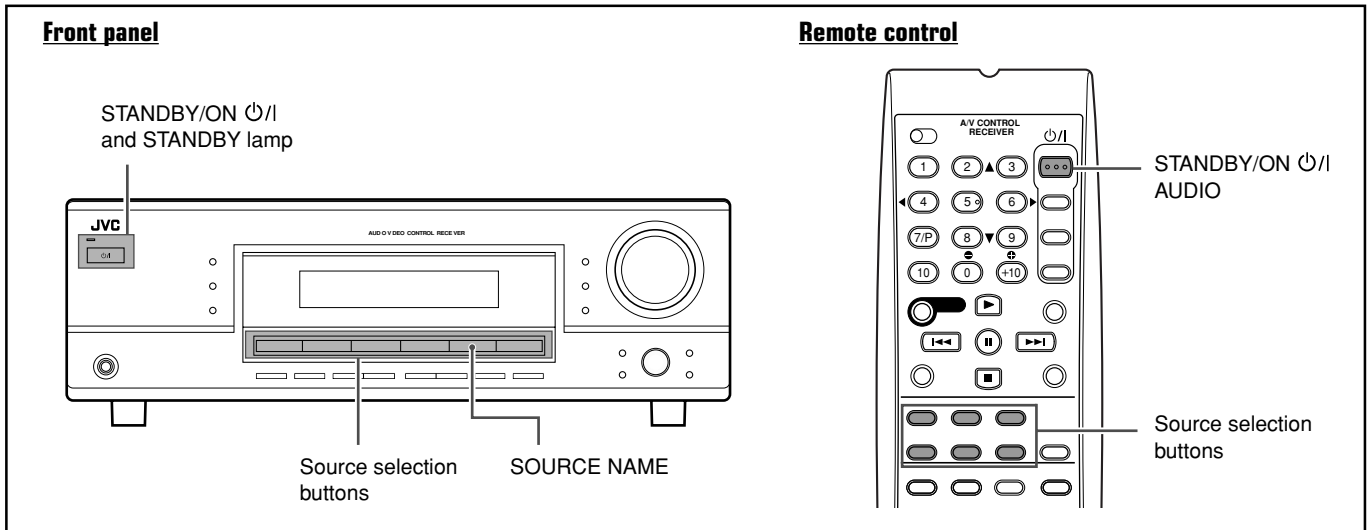

Turning On the Power

Press STANDBY/ON ϕ /I (or STANDBY/ON ϕ /I AUDIO on the remote control).

The STANDBY lamp goes off. The name of the current source (or station frequency) appears on the display.

To turn off the power (into standby mode)

Press STANDBY/ON ϕ /I (or STANDBY/ON ϕ /I AUDIO on the remote control) again.

The STANDBY lamp lights up.

Note:

A small amount of power is consumed in standby mode. To turn the power off completely, unplug the AC power cord.

Selecting the Source to Play

Press one of the source selection buttons.
The selected source name appears on the display.

On the front panel

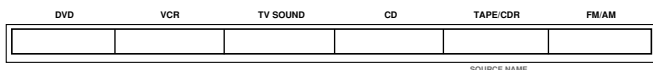

From the remote control

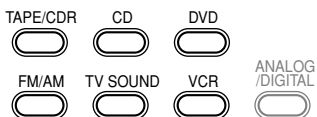

- DVD: Select the DVD player.
- VCR: Select the VCR.
- TV SOUND: Select the TV sound.
- CD*: Select the CD player.
- TAPE/CDR*: Select the cassette deck (or the CD recorder).
- FM/AM*: Select an FM or AM broadcast.
 - Each time you press the button, the band alternates between FM and AM.

Notes:

- When connecting a CD recorder to the TAPE/CDR jacks, change the source name to CDR so that "CDR" appears on the display when selected as the source. See "Changing the Source Name" below.
- When you have connected some digital source components using the digital terminals (see page 9), you need to select the digital input terminals (see page 14).
- When you press one of the source selection buttons on the remote control marked with an asterisk (*), the receiver automatically turns on.

Changing the Source Name



When you have connected a CD recorder to the TAPE/CDR jacks on the rear panel, change the source name to CDR so that "CDR" appears on the display when selected as the source.

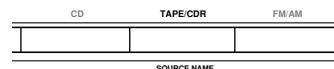

1 Press TAPE/CDR (SOURCE NAME) on the front panel.

- Make sure "TAPE" appears on the display.

2 Press again and hold SOURCE NAME (TAPE/CDR) on the front panel until "ASSIGN CDR" appears on the display.

To change the source name from "CDR" to "TAPE," repeat the same procedure above (in step 1, make sure "CDR" appears on the display).

Note:

- Without changing the source name, you can still use the connected components; however, you may experience one of the following inconveniences:
- A different source name will appear on the display when you select the target component.
 - You cannot use the digital input (see page 14) for the CD recorder.
 - You cannot use the COMPU LINK remote control system (see page 26) to operate the target component.

Basic Operations

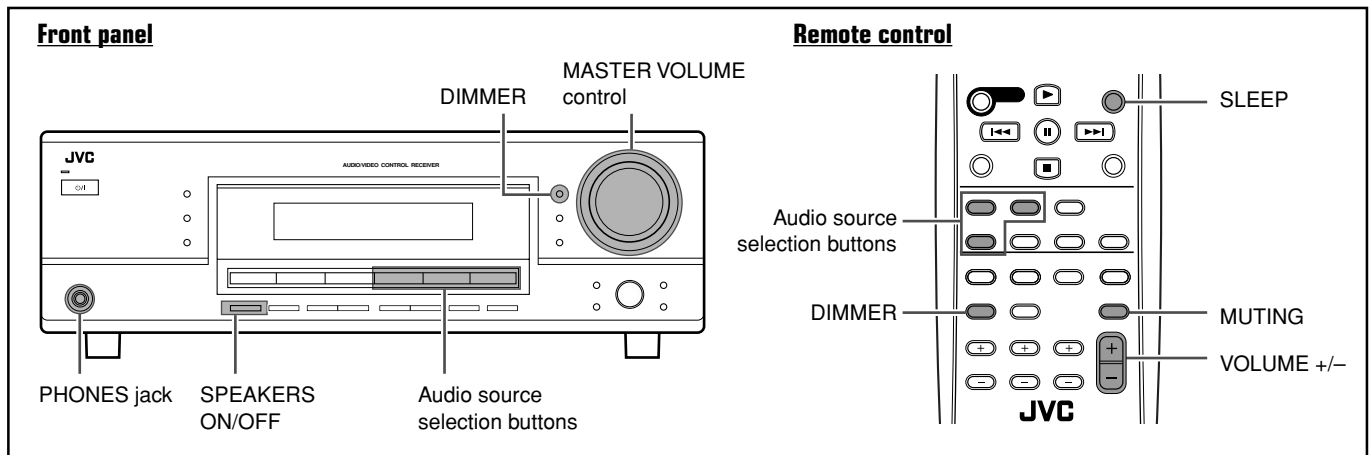

Selecting Different Sources for Picture and Sound

You can watch the picture from a video component while listening to sound from another component.

Press one of the audio source selection buttons while watching the picture from a video component such as the VCR or DVD player.

- Once you have selected a video source, pictures of the selected source are sent to the TV until you select another video source.

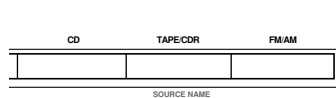

On the front panel

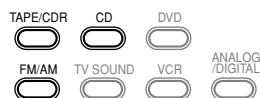

From the remote control

Adjusting the Volume

On the front panel

To increase the volume, turn MASTER VOLUME control clockwise.

To decrease the volume, turn MASTER VOLUME control counterclockwise.

From the remote control

To increase the volume, press VOLUME +.

To decrease the volume, press VOLUME -.

The volume level can be adjusted within a range of "0" (minimum) to "50" (maximum).

CAUTION:

Always set the volume to the minimum before starting any source. If the volume is set at a high level, the sudden blast of sound energy can permanently damage your hearing and/or ruin your speakers.

Listening with Headphones Only



You must turn off the speakers when you listen with headphones.

1 Press SPEAKERS ON/OFF on the front panel.

"HEADPHONE" appears on the display for a while.

The SPK indicator goes off and the H.PHONE indicator lights up.

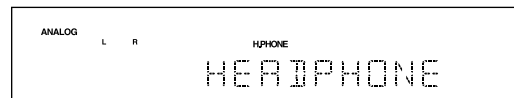

This cancels the Surround/DSP modes currently selected and activates the HEADPHONE mode (see below).

2 Connect a pair of headphones to the PHONES jack on the front panel.

HEADPHONE mode

When using the headphones, the following signals are sent to the headphones regardless of your speaker setting:

- For 2 channel sources, the front left and right channel signals are sent directly to the headphones.
- For multi-channel sources, the front left/right, center, and surround left/right channel signals are down-mixed and then sent to the headphones.

You can enjoy multi-channel sound sources using the headphones.

Note:

While in the HEADPHONE mode, you cannot use any Surround/DSP modes (see pages 22 to 25).

After using the headphones

1 Press SPEAKERS ON/OFF on the front panel to activate the speakers.

The H.PHONE indicator goes off and the SPK indicator lights up.

2 Disconnect the headphones.

CAUTION:

Be sure to turn down the volume

- Before connecting or putting on headphones, as high volume can damage both the headphones and your hearing.
- Before turning on speakers again, as high volume may be output from the speakers.

Turning Off the Sound Temporarily—Muting



You can turn off the volume temporarily.

Press **MUTING on the remote control** to mute the sound through all speakers or headphones.

- “MUTING” appears on the display and the volume turns off (the VOLUME indicator goes off).

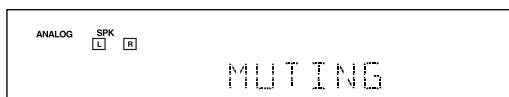

To restore the sound, press **MUTING** again.

The **VOLUME** indicator lights up on the display.

- Turning **MASTER VOLUME** control on the front panel or pressing **VOLUME +/-** on the remote control also restores the sound.

Changing the Display Brightness—DIMMER

You can dim the display.

Press **DIMMER**.

- Each time you press the button, the display dims and brightens alternately.

Turning Off the Power with the Sleep Timer



You can fall asleep while listening to music—Sleep Timer.

Press **SLEEP on the remote control** repeatedly.

- The **SLEEP** indicator lights up on the display. Each time you press the button, the shut-off time changes in 10 minute intervals as follows:

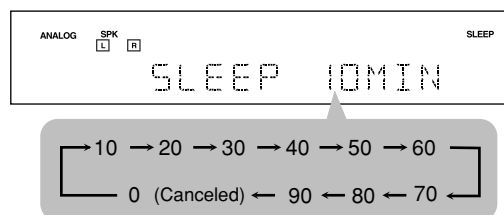

When the shut-off time comes, the receiver turns off automatically.

To check or change the shut-off time, press **SLEEP** once.

The remaining time (in minutes) until the shut-off time appears.

- To change the shut-off time, press **SLEEP** repeatedly.

To cancel the Sleep Timer, press **SLEEP** repeatedly until “SLEEP 0MIN” appears on the display. (The **SLEEP** indicator goes off.)

- Turning off the power also cancels the Sleep Timer.

Basic adjustment auto memory

This receiver memorizes sound settings for each source when—:

- you turn off the power,
- you change the source, and
- you assign the source name.

When you change the source, the memorized settings for the newly selected source are automatically recalled.

The following can be stored for each source:

- Input attenuator mode (see page 16)
- Tone adjustment (see page 18)
- Speaker output level (see pages 18 and 19)
- Surround/DSP mode selection (see pages 24 and 25)

Notes:

- You cannot assign and store different settings for digital input mode and analog input mode.
- If the source is FM or AM, you can assign a different setting for each band.

For recording

You can record any sources playing through the receiver to a cassette deck (or a CD recorder) connected to the TAPE/CDR jacks and the VCR connected to the VCR jacks at the same time.

While recording, you can listen to the selected sound source at whatever sound level you like without affecting the sound levels of the recording.

Note:

The output volume level, tone adjustment (see page 18), and Surround/DSP modes (see pages 24 and 25) do not affect the recording.

Basic Settings

Basic Settings Using MULTI JOG Dial

After connecting and placing speakers, you need to make basic settings for the following items according to your listening conditions.

- Speaker information (see the right column and page 14)
- Digital input terminal sources (see page 14)

■ Operating buttons

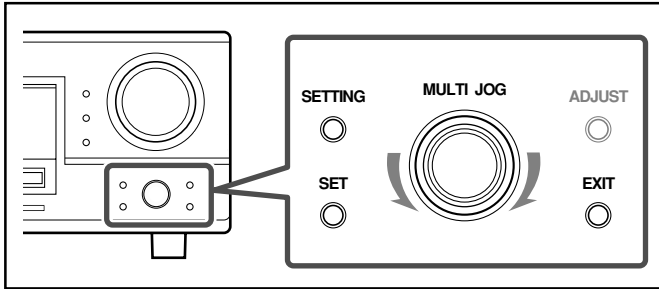

Buttons	To do
SETTING	Enter the receiver into the basic setting mode.
MULTI JOG	<ul style="list-style-type: none"> • Select an item to adjust after pressing SETTING. • Adjust the selected item after pressing SET.
SET	Determine the item to adjust.
EXIT	Exit from the basic setting mode or return to the previous step.

■ Operating procedure

Ex. Setting the subwoofer information

Before you start, remember...

There is a time limit in doing the following steps. If the setting is canceled before you finish, start again from step 1.

1 Press SETTING.

The last selected item appears on the display.

2 Turn MULTI JOG dial to select an item you want to adjust.

SUBWOOFER ⇄ FRNT SPEAKERS ⇄ CNTR SPEAKER ⇄
 SURR SPEAKERS ⇄ DISTANCE UNIT ⇄ FRNT DISTANCE ⇄
 CNTR DISTANCE ⇄ SURR DISTANCE ⇄ CROSSOVER ⇄
 LFE ATTENUATE ⇄ D_COMPRESSION ⇄ DIGITAL IN ⇄
 (back to the beginning)

3 Press SET.

The current setting of the selected item appears on the display.

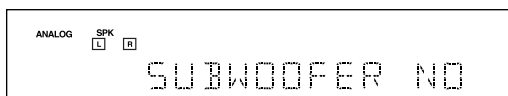

Ex.: When "SUBWOOFER" is selected.

4 Turn MULTI JOG dial to adjust the selected item.

Select "SUBWOOFER YES" if a subwoofer is connected.

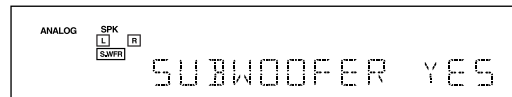

Ex.: When "SUBWOOFER YES" is selected.

5 Press EXIT.

To adjust other items, repeat steps 2 to 5.

To finish the setting, go to step 6.

6 Press EXIT again.

The receiver exits from the basic setting mode.

Setting the Speaker Information

"NO" for the subwoofer, "LARGE" for the front speakers, and "SMALL" for the center and surround speakers are initial settings.

To get best possible sound, change the subwoofer and speaker settings to fit your listening conditions.

■ Subwoofer information—SUBWOOFER

Register whether you have connected a subwoofer or not.

YES	Select this when you have connected a subwoofer. You can adjust the subwoofer output level (see page 19).
NO	Select this when you have not connected or have disconnected a subwoofer.

■ Speaker size—FRNT (Front) SPEAKERS, CNTR (Center) SPEAKER, SURR (Surround) SPEAKERS

Register the sizes of all the connected speakers.

- When you change your speakers, register the information about the speakers again.

LARGE	Select this when the size of the cone speaker unit built in your speaker is greater than 12 cm.
SMALL	Select this when the size of the cone speaker unit built in your speaker is smaller than 12 cm.
NONE	Select this when you have not connected a speaker. (Not selectable for the front speakers.)

Notes:

- If you have selected "NO" for the subwoofer setting, you can only select "LARGE" for the front speaker setting.
- If you have selected "SMALL" for the front speaker setting, you cannot select "LARGE" for the center and surround speaker settings.

■ **Speaker distance—DISTANCE UNIT, FRNT (Front) DISTANCE, CNTR (Center) DISTANCE, SURR (Surround) DISTANCE**

Select the unit to measure the distance between your listening position and speakers—"METER" or "FEET."

After selecting the measuring unit, select the appropriate speaker distance for each speaker within the range of "0.3m" ("1FT") to "9.0m" ("30FT") by 0.3 m (1 foot) step.

Example: In this case, set "FRNT DISTANCE" to "3.0m" ("10FT"), "CNTR DISTANCE" to "2.7m" ("9FT"), and "SURR DISTANCE" to "2.4m" ("8FT").

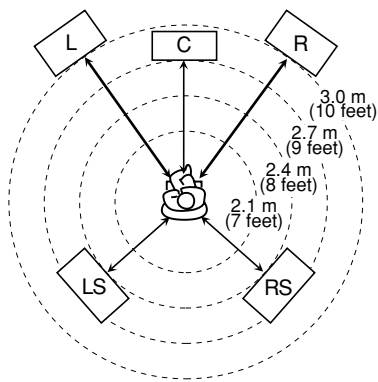

- "METER" for the unit and "3.0m" ("10FT") for all speakers are the initial settings.

Note:

If you have selected "NONE" for the center and surround speakers setting, you cannot set the speaker distance for the center and surround speakers.

■ **Crossover frequency—CROSSOVER**

Small speakers cannot reproduce the bass sounds efficiently. If you use a small speaker in any position, this receiver automatically reallocates the bass sound elements assigned to the small speaker to other large speakers. To use this function properly, set the crossover frequency according to the table below:

Crossover frequency	Size of cone speaker unit built in the small speaker
80HZ	about 12 cm
100HZ	about 10 cm (initial setting)
120HZ	about 8 cm
150HZ	about 6 cm
200HZ	less than 5 cm

- If you have selected "LARGE" for all speakers, this function will not take effect ("CROSS OFF" appears).

■ **Low Frequency Effect attenuator—LFE ATTENUATE**

If the bass sound is distorted while playing back software encoded with Dolby Digital or DTS Digital Surround, select "-10dB" to activate the Low Frequency Effect attenuator.

- This function takes effect only when the LFE signals come in.

0dB Normally select this (initial setting).

-10dB Select this when the bass sound is distorted.

■ **Dynamic range compression—D_COMPRESSION**

You can compress the dynamic range (difference between maximum sound and minimum sound) of the reproduced sound. This is useful when using surround sound at night.

- This function takes effect only when playing back a source using Dolby Digital.

MID Select this when you want to reduce the dynamic range a little (initial setting).

MAX Select this when you want to apply the compression effect fully. (Useful at night.)

OFF Select this when you want to enjoy surround sound with its full dynamic range. (No effect applied.)

Selecting the Digital Input Terminals—DIGITAL IN

When you use the digital input terminals, register which components are connected to which terminals (DIGITAL 1/2) so that the correct source name will appear when you select the digital source.

Select the appropriate option from the following:

- | | | | | | |
|-------------------------|---|------------|---|-------------|---|
| 1 DVD 2 CD | ⇄ | 1 DVD 2 TV | ⇄ | 1 DVD 2 CDR | ⇄ |
| 1 CD 2 DVD | ⇄ | 1 CD 2 TV | ⇄ | 1 CD 2 CDR | ⇄ |
| 1 TV 2 DVD | ⇄ | 1 TV 2 CD | ⇄ | 1 TV 2 CDR | ⇄ |
| 1 CDR 2 DVD | ⇄ | 1 CDR 2 CD | ⇄ | 1 CDR 2 TV | ⇄ |
| (back to the beginning) | | | | | |

Note:

When shipped from the factory, the DIGITAL IN terminals have been set for use with the following components:

- DIGITAL 1 (coaxial): For DVD player
- DIGITAL 2 (optical): For CD player

Basic Settings

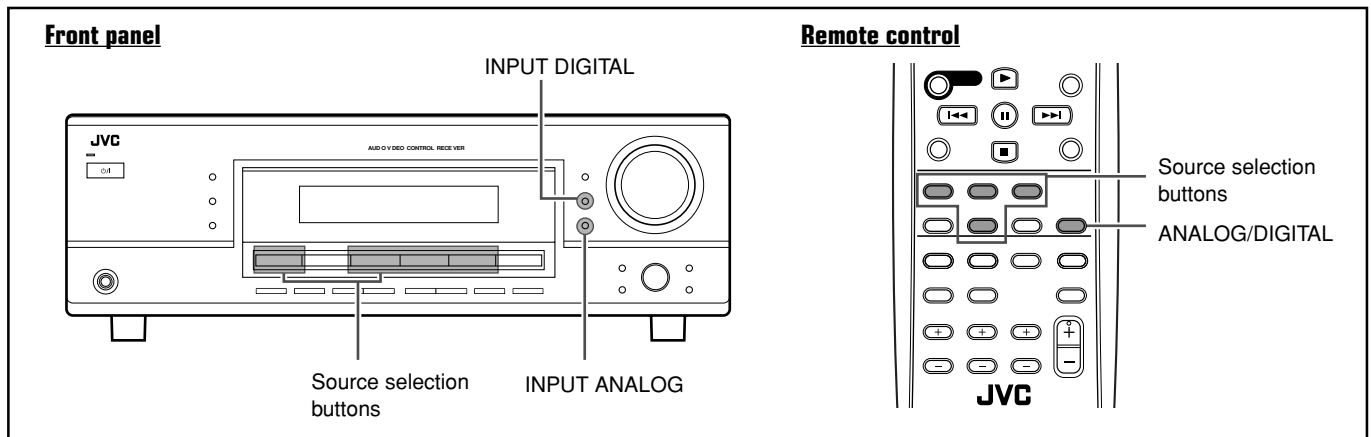

Selecting the Analog or Digital Input Mode

When you have connected digital source components using both the analog connection (see pages 7 and 8) and the digital connection (see page 9) methods, you need to select the input mode correctly.

1 Press one of the source selection buttons—DVD, TV SOUND, CD, or TAPE/CDR*—for which you want to change the input mode.

Note:

* Among the sources listed above, you can select the digital input only for the sources for which you have selected the digital input terminals. (See “Selecting the Digital Input Terminals—DIGITAL IN” on page 14.)

2 Select digital input mode. On the front panel

Press INPUT DIGITAL.

“DIGITAL AUTO” appears on the display. The DIGITAL AUTO indicator also lights up.

To change the input mode back to analog input, press INPUT ANALOG.

“ANALOG” appears on the display for a while. The ANALOG indicator lights up.

From the remote control

Press ANALOG/DIGITAL.

- Each time you press the button, the input mode alternates between the analog input (“ANALOG”) and the digital input (“DIGITAL AUTO”).

DIGITAL AUTO Select this for the digital input mode. The receiver automatically detects the incoming signal format.

ANALOG Select this for the analog input mode (initial setting).

If the following symptoms occur while playing Dolby Digital or DTS encoded software with “DIGITAL AUTO” selected, change the digital input mode.

- Sound does not come out at the beginning of playback.
- Noise comes out while searching or skipping chapters or tracks.

Press **INPUT DIGITAL on the front panel** repeatedly to select “DOLBY DIGITAL” or “DTS SURROUND.”



- Each time you press the button, the digital input mode changes as follows:

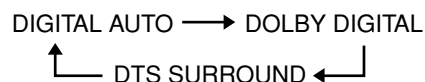

- To play back software encoded with Dolby Digital, select “DOLBY DIGITAL.”
- To play back software encoded with DTS Digital Surround, select “DTS SURROUND.”

Note:

When you turn off the power or select another source, “DOLBY DIGITAL” or “DTS SURROUND” is canceled and the digital input mode is automatically reset to “DIGITAL AUTO.”

The ANALOG indicator and digital signal format indicators on the display indicate what type of signal comes into the receiver.

ANALOG	Lights when the analog input is selected.
LINEAR PCM	Lights when Linear PCM signals come in.
DIGITAL	<ul style="list-style-type: none"> • Lights when Dolby Digital signals come in. • Flashes when “DOLBY DIGITAL” is selected for software not encoded with Dolby Digital signals.
dts	<ul style="list-style-type: none"> • Lights when DTS signals come in. • Flashes when “DTS SURROUND” is selected for software not encoded with DTS signals.

Note:

When “DIGITAL AUTO” cannot recognize the incoming signals, no digital signal format indicators light up on the display.

Sound Adjustments

Front panel

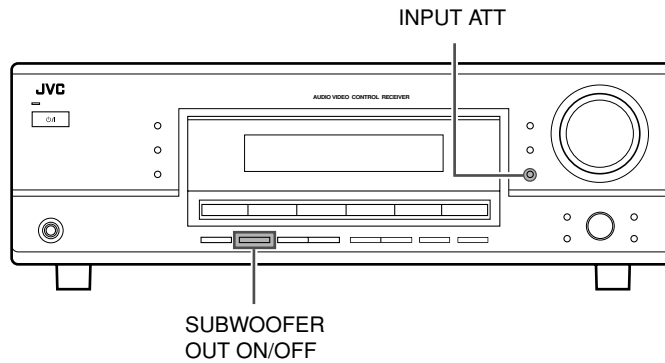

Attenuating the Input Signal



When the input level of the analog source is too high, the sound will be distorted. If this happens, you need to attenuate the input signal level to prevent the distortion.

Once this has been adjusted, this receiver memorizes the adjustment for each source.

Press and hold **INPUT ATT** on the front panel so that the **INPUT ATT** indicator lights up on the display.

- Each time you press and hold the button, the Input Attenuator mode turns on (“INPUT ATT ON”) or off (“INPUT NORMAL”).

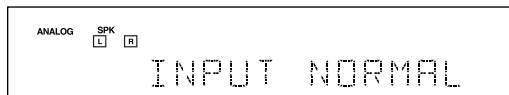
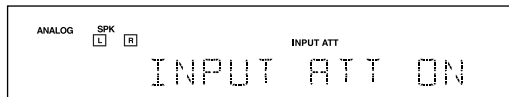

Turning Off the Subwoofer



When the subwoofer is set to “YES” (see page 13), you can choose to turn off subwoofer output.

Press **SUBWOOFER OUT ON/OFF** on the front panel to turn off the subwoofer.

“SUBWOOFER OFF” appears on the display for a while and the **S.WFR** indicator goes off.

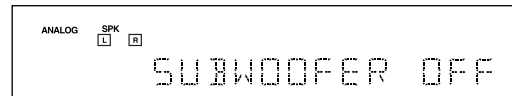

The subwoofer sound comes out of the front speakers.

To turn on the subwoofer, press the button again.

Notes:

- This button does not work when the subwoofer is set to “NO” (see page 13). In this case, “NO SUBWOOFER” will appear on the display for a while.
- You cannot turn off subwoofer output when the front speaker size is set to “SMALL.”
- When you change the subwoofer setting from “NO” to “YES,” subwoofer output is automatically turned on.

Sound Adjustments

Sound Adjustments Using MULTI JOG Dial

You can adjust the sound using MULTI JOG dial on the front panel.

- Tone—BASS, TREBLE
- Subwoofer output level*—SUBWFR LEVEL
- Speakers' output level*—
FRONT L/R LEVEL, CENTER LEVEL, SURR L/R LEVEL
- Effect level for DAP modes—EFFECT
- Panorama control for Pro Logic II Music—PANORAMA CTRL

* You can also use the remote control to adjust these items (see pages 18 and 19).

Operating buttons

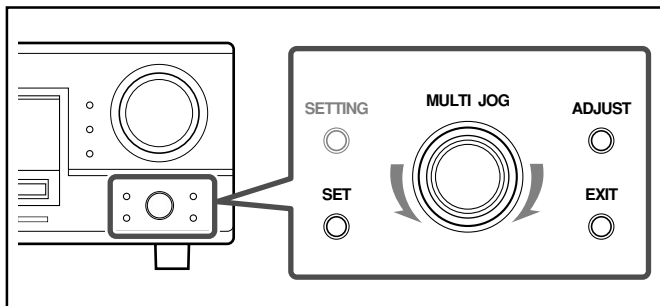

Buttons	To do
ADJUST	Enter the receiver into the sound adjusting mode.
MULTI JOG	<ul style="list-style-type: none"> • Select an item to adjust after pressing ADJUST. • Adjust the selected item after pressing SET.
SET	Determine the item to adjust.
EXIT	Exit from the sound adjusting mode or return to the previous step.

Operating procedure

Ex. When adjusting the bass sound

Before you start, remember...

There is a time limit in doing the following steps. If the setting is canceled before you finish, start again from step 1.

1 Press ADJUST.

The last selected item appears on the display.

2 Turn MULTI JOG dial to select an item you want to adjust.

BASS ⇄ TREBLE ⇄ SUBWFR LEVEL* ⇄
FRONT L LEVEL ⇄ FRONT R LEVEL ⇄
CENTER LEVEL* ⇄ SURR L LEVEL* ⇄
SURR R LEVEL* ⇄ EFFECT* ⇄
PANORAMA CTRL* ⇄ (back to the beginning)

* These items may not be selected depending on how the following are set:

- Subwoofer setting
- Speaker size setting
- The current Surround/DSP mode

For details, see the next page and "Adjustable items and selected Surround/DSP mode" on page 25.

3 Press SET.

The current setting of the selected item appears on the display.

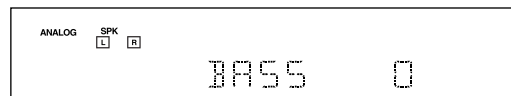

EX.: When "BASS" is selected.

4 Turn MULTI JOG dial to select an appropriate value.

Adjust the bass sound level within the range of -10 dB to +10 dB.

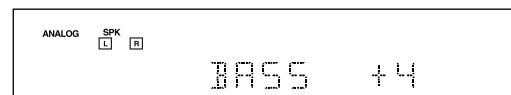

EX.: When the bass level is adjusted to "+4."

5 Press EXIT.

To adjust other items, repeat steps 2 to 5.
To finish the adjustment, go to step 6.

6 Press EXIT again.

The receiver exits from the sound adjusting mode.

■ Tone—BASS, TREBLE

Adjust the bass and treble sounds as you like (–10 dB to +10 dB in 2 step intervals).

- “0” is the initial setting.

■ Subwoofer output level—SUBWFR (Subwoofer) LEVEL

Adjust the subwoofer output level (–10 dB to +10 dB in 1 step intervals).

- “0” is the initial setting.

Note:

Subwoofer output level cannot be adjusted in the following cases:

- When “SUBWOOFER NO” is selected for the subwoofer setting (see page 13).
- When the HEADPHONE mode is in use (see page 11).

■ Speakers’ output level

Adjust the speakers’ output level so that you can hear sounds from each speaker at an equal level (–10 dB to +10 dB in 1 step intervals).

- “0” is the initial setting for all speakers.

FRONT L LEVEL	Left front speaker output level
FRONT R LEVEL	Right front speaker output level
CENTER LEVEL*	Center speaker output level
SURR L LEVEL*	Left surround speaker output level
SURR R LEVEL*	Right surround speaker output level

* You can adjust these items depending on the current speaker settings (see page 13) and Surround/DSP mode (see “Adjustable items and selected Surround/DSP mode” on page 25).

Notes:

- You cannot adjust the center speaker output level when the center speaker size is set to “NONE” (see page 13).
- You cannot adjust the surround speaker output levels when the surround speaker size is set to “NONE” (see page 13).

■ Effect level for DAP modes—EFFECT

You can adjust the effect level for DAP modes only when one of the DAP modes is activated (EFFECT 1 to EFFECT 5).

“EFFECT 3” is the initial setting. As the number increases, the effect becomes more stronger.

- For DAP modes, see page 23.

■ Panorama control for Pro Logic II Music—PANORAMA CTRL (Control)

You can turn on or off the Panorama control for Pro Logic II Music only when “PLII MUSIC” is activated.

Select “PANORAMA ON” to enjoy “wraparound” sound effect with side-wall image (“OFF” is the initial setting).

- For Pro Logic II Music, see page 22.

Sound Adjustments Using Remote Control

You can also use the remote control to adjust the speaker output levels and the subwoofer output level.

- You can use the test tone to make your favourite adjustments (except for subwoofer level adjustment).

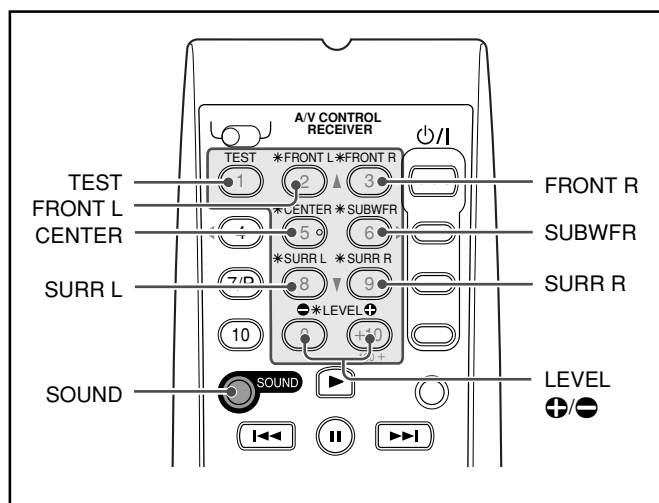

Adjusting Speaker Output Levels Using Test Tone

The center and surround speakers are temporarily activated and you can adjust them when you are listening to stereo sound or one of the DAP modes is activated.

Notes:

- You cannot adjust the center speaker output level when the center speaker size is set to “NONE” (see page 13).
- You cannot adjust the surround speaker output levels when the surround speaker size is set to “NONE” (see page 13).

1 Press SOUND.

The 10 keys are activated for sound adjustments.

Sound Adjustments

2 Press TEST.

“TEST TONE L” starts flashing on the display and a test tone comes out of the speakers in the following order:

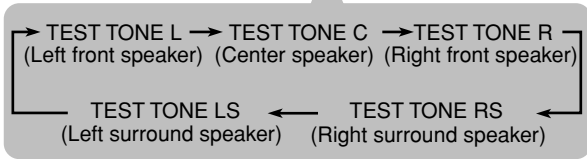

Check whether you can hear the tone through all the speakers at an equal level or not.

Note:

If the center and surround speakers are set to “NONE,” no test tone is available.

3 Select a speaker you want to adjust.

Press one of the following buttons:

FRONT L	Left front speaker
FRONT R	Right front speaker
CENTER	Center speaker
SURR L	Left surround speaker
SURR R	Right surround speaker

4 Press LEVEL \oplus/\ominus to adjust the selected speaker output level (–10 dB to +10 dB).

When you press the button once, the current setting of the selected speaker appears on the display and a test tone comes out of the selected speaker.

• “0” is the initial setting for all speakers.

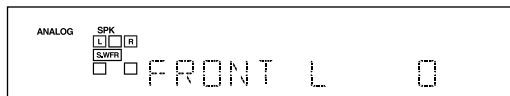

Ex.: When you press FRONT L in step 3.

Repeat steps 3 and 4 to adjust other speaker output levels so that you can hear the tone through all the speakers at an equal level.

5 Press SOUND, then press TEST to stop the test tone.

Adjusting Subwoofer Output Level

Make sure the subwoofer setting is set to “YES” (see page 13).

1 Press SOUND.

The 10 keys are activated for sound adjustments.

2 Press SUBWFR.

3 Press LEVEL \oplus/\ominus to adjust the subwoofer output level (–10 dB to +10 dB).

When you press the button once, the current setting of the subwoofer appears on the display.

• “0” is the initial setting.

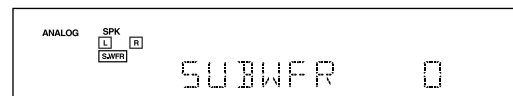

Note:

Subwoofer output level cannot be adjusted in the following cases:

- When “SUBWOOFER NO” is selected for the subwoofer setting (see page 13).
- When the HEADPHONE mode is in use (see page 11).

When you use the 10 keys to operate your target source after sound adjustments, press the source selection button first so that the 10 keys work for the target source.

Tuner Operations

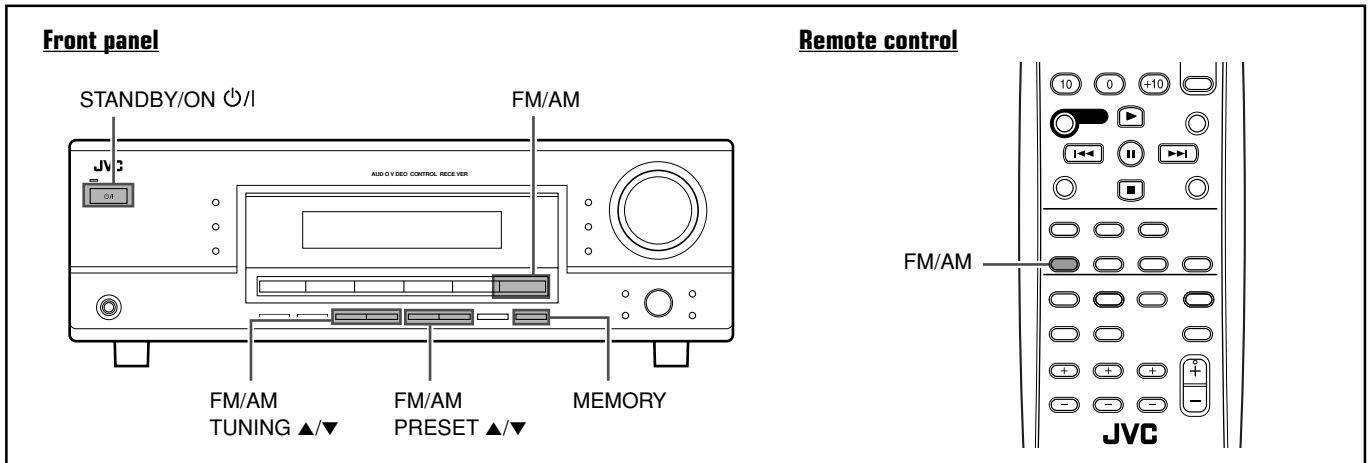

Setting the AM Tuner Interval Spacing



Some countries space AM stations 9 kHz apart, and other countries use 10 kHz spacing. 9 kHz spacing is the initial setting.

To select the 10 kHz interval:

Be sure the receiver is turned off, but is plugged into an AC outlet. Hold down FM/AM TUNING ▲ and press STANDBY/ON ⏻. "10k STEP" appears on the display. Now the 10 kHz interval is selected.

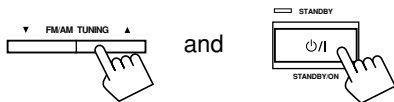

To change back to the 9 kHz interval:

Be sure the receiver is turned off, but is plugged into an AC outlet. Hold down FM/AM TUNING ▼ and press STANDBY/ON ⏻. "9k STEP" appears on the display. Now the 9 kHz interval is selected.

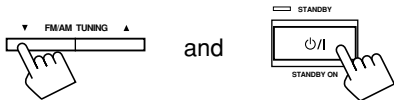

Tuning in to Stations Manually

1 Press FM/AM to select the band (FM or AM).

The last received station of the last selected band is tuned in.

- Each time you press the button, the band alternates between FM and AM.

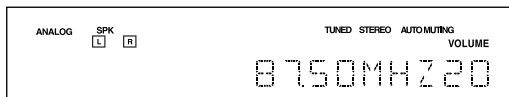

Ex.: When the FM band is selected.

2 Press FM/AM TUNING ▲/▼ on the front panel repeatedly until you find the frequency you want.



Notes:

- When you hold FM/AM TUNING ▲/▼ in step 2, the frequency keeps changing until a station is tuned in.
- When a station of sufficient signal strength is tuned in, the TUNED indicator lights up on the display.
- When an FM stereo program is received, the STEREO indicator also lights up.

Using Preset Tuning

Once a station is assigned to a channel number, the station can be quickly tuned in. You can preset up to 30 FM and 15 AM stations.

Storing the Preset Stations



Before you start, remember...

There is a time limit in doing the following steps. If the setting is canceled before you finish, start again from step 2.

1 Tune in to the station you want to preset (see "Tuning in to Stations Manually").

If you want to store the FM reception mode for this station, select the FM reception mode you want. See "Selecting the FM Reception Mode" on page 21.

2 Press MEMORY.

The CH- indicator lights up and the channel number position will flash on the display for about 5 seconds.

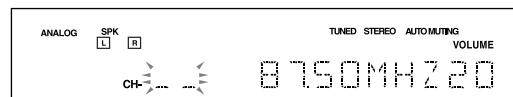

Ex.: When the FM band is selected in step 1.

3 Press FM/AM PRESET ▲/▼ to select a channel number while the channel number position is flashing.

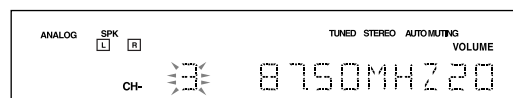

Ex.: When channel number "3" is selected.

TO BE CONTINUED TO THE NEXT PAGE

Tuner Operations

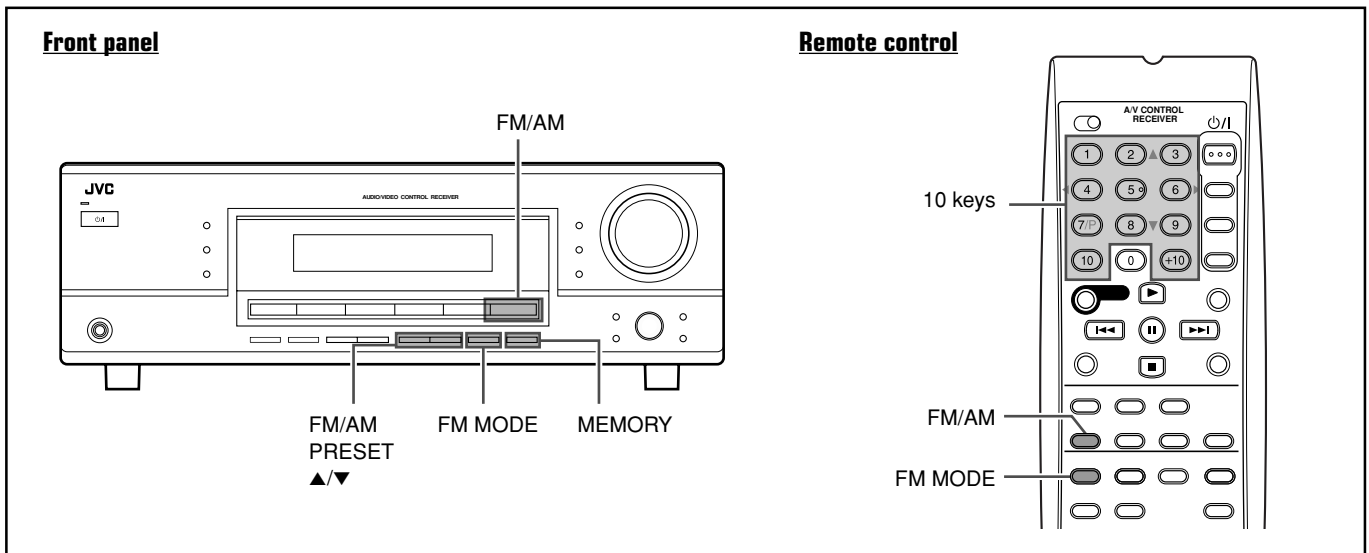

- 4 Press MEMORY again while the selected channel number is flashing on the display.**
The selected channel number stops flashing.
The station is assigned to the selected channel number.

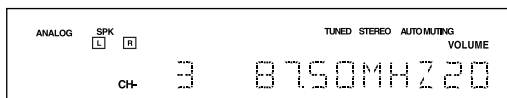

- 5 Repeat steps 1 to 4 until you store all the stations you want.**

To erase a stored preset station, store a new station on a used number.
The station previously stored will be erased.

Tuning in to a Preset Station

On the front panel

- 1 Press FM/AM to select the band (FM or AM).**
The last received station of the last selected band is tuned in.
• Each time you press the button, the band alternates between FM and AM.
- 2 Press FM/AM PRESET ▲/▼ repeatedly until you find the channel you want.**

From the remote control

- 1 Press FM/AM to select the band (FM or AM).**
The last received station of the last selected band is tuned in and the 10 keys now work for the tuner operation.
• Each time you press the button, the band alternates between FM and AM.
- 2 Press 10 keys (1 – 10, +10) to select a preset channel number.**
• For channel number 5, press 5.
• For channel number 15, press +10 then 5.
• For channel number 20, press +10 then 10.
• For channel number 30, press +10, +10, then 10.

Note:

When you use 10 keys, be sure that they are activated for the tuner, not for the CD or other functions. (See page 29.)

Selecting the FM Reception Mode

When an FM stereo broadcast is hard to receive or noisy, you can change the FM reception mode.

- You can store the FM reception mode for each preset station. (See page 20.)

Press FM MODE while listening to an FM station.

- Each time you press the button, the FM reception mode alternates between "AUTO" and "MONO."

AUTO Normally select this (initial setting).
When a program is broadcast in stereo, you will hear stereo sound; when in monaural, you will hear monaural sound. This mode is also useful to suppress static noise between stations. The AUTO MUTING indicator lights up on the display.

MONO Select this to improve the reception (but stereo effect will be lost).
In this mode, you will hear noise while tuning in to the station. The AUTO MUTING indicator goes off on the display. (The STEREO indicator goes off.)

Creating Realistic Sound Fields

You can use the following Surround and DSP modes to reproduce a realistic sound field:

Surround modes

- Dolby
 - Dolby Pro Logic II
 - Dolby Digital
- DTS Digital Surround

DSP modes

- DAP modes
- All Channel Stereo

Surround modes

■ Dolby

Dolby Pro Logic II*

Dolby Pro Logic II has a multi-channel playback format to decode all 2 channel sources—stereo source and Dolby Surround encoded source—into 5.1 channels.

Matrix-based encoding/decoding method for Dolby Pro Logic II makes no limitation for the cutoff frequency of the rear treble and enables stereo rear sound compared to conventional Dolby Pro Logic.

Dolby Pro Logic II enables reproduction of spacious sound from original sound without adding any new sounds and tonal colorations.

Dolby Pro Logic II has two modes—Movie mode and Music mode:

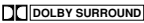
Pro Logic II Movie (PLII MOVIE)—suitable for the reproduction of Dolby Surround encoded sources bearing the mark . You can enjoy a sound field very close to the one created with discrete 5.1 channel sounds.

Pro Logic II Music (PLII MUSIC)—suitable for the reproduction of any 2 channel stereo music sources. You can enjoy wide and deep sound by using this mode. For this mode, Panorama control can be selected, which gives “wraparound” sound effect with side-wall image.

- When Dolby Pro Logic II is activated, the  PRO LOGIC II indicator lights up on the display.

Dolby Digital*

Used to reproduce multi-channel sound tracks of the software encoded with Dolby Digital ().

- To use software encoded with Dolby Digital, connect the source component to the digital terminal on the rear of this receiver. (See page 9.)

Dolby Digital 5.1 channel encoding method (so-called discrete multi-channel digital audio format) records and digitally compresses the left front channel, right front channel, center channel, left surround channel, right surround channel, and LFE channel signals.

Since each channel is completely independent from the other channel signals to avoid interference, you can obtain much better sound quality with many stereo and surround effects.

- When Dolby Digital signal comes in, the  DIGITAL indicator lights up on the display.

Note:

Dolby Digital software can roughly be grouped into two categories—multi-channel (up to 5.1 channel) and 2 channel software. To enjoy surround sounds while playing Dolby Digital 2 channel software, you can use Dolby Pro Logic II.

■ DTS Digital Surround**

Used to reproduce multi-channel sound tracks of software encoded with DTS Digital Surround ().

- To use software encoded with DTS Digital Surround, connect the source component to the digital terminal on the rear of this receiver. (See page 9.)

DTS Digital Surround is another discrete multi-channel digital audio format available on CD, LD, and DVD software. Compared to Dolby Digital, the audio compression ratio is relatively low. This fact allows DTS Digital Surround format to add breadth and depth to the reproduced sounds. As a result, DTS Digital Surround features natural, solid, and clear sound.

- When DTS signal comes in, the  indicator lights up on the display.

Typical multi-channel (5.1 channel) reproduction

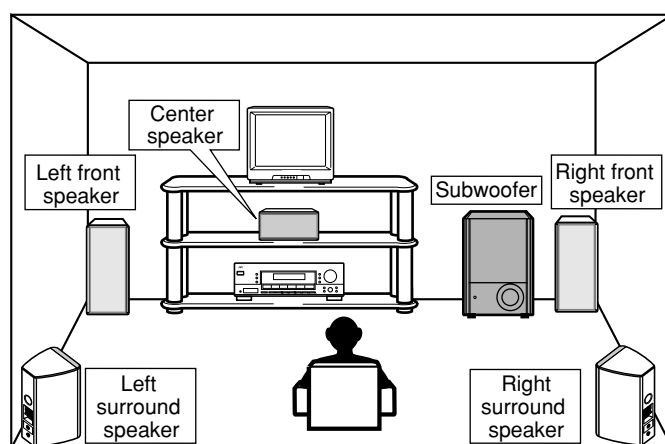

* Manufactured under license from Dolby Laboratories. “Dolby”, “Pro Logic”, and the double-D symbol are trademarks of Dolby Laboratories.

** “DTS” and “DTS Digital Surround” are registered trademarks of Digital Theater Systems, Inc.

Creating Realistic Sound Fields

DSP modes

■ DAP (Digital Acoustic Processor) modes

DAP modes have been designed to create important acoustic surround elements.

The sound heard in a live club, dance club, hall or pavilion consists of direct sound and indirect sound—early reflections and reflections from behind. Direct sounds reach the listener directly without any reflection. On the other hand, indirect sounds are delayed by the distances of the ceiling and walls (see the diagram on the right).

These indirect sounds are important elements of the acoustic surround effects. The DAP mode can reproduce a realistic sound field by adding these indirect sounds.

DAP modes can be used when the front and surround speakers are connected to this receiver (without respect to the center speaker connection: no sound comes out of the center speaker even if it is connected).

The following DAP modes are provided with this receiver:

LIVE CLUB	Gives the feeling of a live music club with a low ceiling.
DANCE CLUB	Gives a throbbing bass beat.
HALL	Gives clear vocal and the feeling of a concert hall.
PAVILION	Gives the spacious feeling of a pavilion with a high ceiling.

These DAP modes can be used to add the acoustic surround effects while reproducing 2 channel stereo software—either analog or digital except Dolby Digital and DTS Digital Surround—and can give you a real “being there” feeling.

- When one of the DAP modes is selected, the DSP indicator lights up on the display.

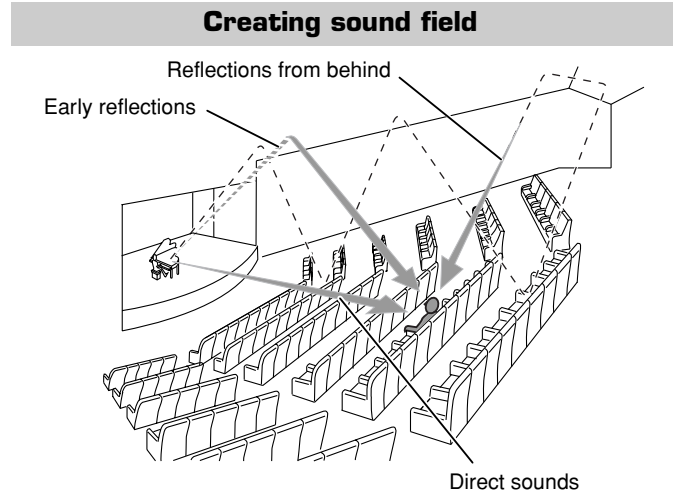

■ All Channel Stereo

This mode can reproduce a larger stereo sound field using all the connected (and activated) speakers.

All Channel Stereo can be used when the front and surround speakers are connected to this receiver without respect to the center speaker connection.

If the center speaker is connected and activated, the same phase of the front left and right signals is emitted through the center speaker.

All Channel Stereo can be used while reproducing 2 channel stereo software, either analog or digital except Dolby Digital and DTS.

- When All Channel Stereo is selected, the DSP indicator lights up on the display.

All Channel Stereo reproduction

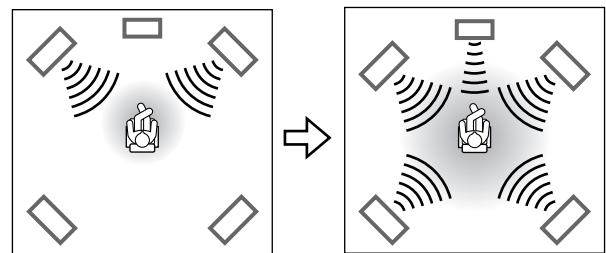

Normal stereo reproduction

Sound reproduced from All Channel Stereo

Available Surround/DSP modes for each input signal

○: Available ×: Not available

Signals \ Modes	SURROUND OFF (stereo)	DOLBY DIGITAL	DTS SURROUND	PLII MOVIE	PLII MUSIC	LIVE CLUB	DANCE CLUB	HALL	PAVILION	ALL CH STEREO
Dolby Digital (Multi-channel)	○	○	×	×	×	×	×	×	×	×
Dolby Digital (2 channel)	○	×	×	○	○	×	×	×	×	×
DTS Digital Surround (Multi-channel)	○	×	○	×	×	×	×	×	×	×
DTS Digital Surround (2 channel)	○	×	×	○	○	×	×	×	×	×
Linear PCM	○	×	×	○	○	○	○	○	○	○
Analog	○	×	×	○	○	○	○	○	○	○

Make sure that you have set the speaker information correctly (see pages 13 and 14).

- If only the front speakers are connected, you cannot use Surround/DSP modes.
- You cannot use DSP modes if no surround speakers are connected.
- Do not change the speaker setting while using any Surround/DSP modes; otherwise, the Surround/DSP modes may be canceled when you deactivate the speakers required for the Surround/DSP modes.

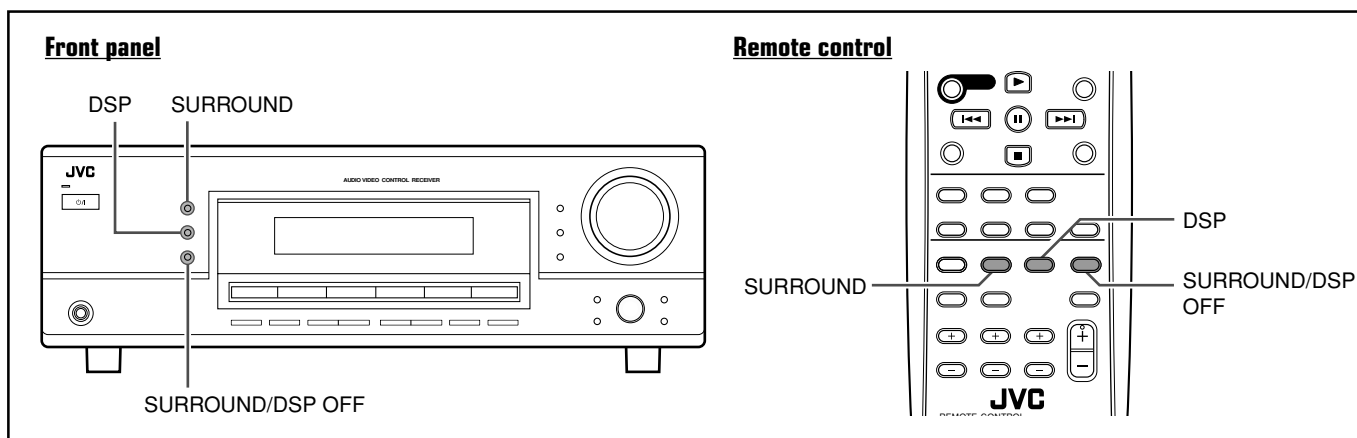

Using Surround Modes

Speaker layouts required for Surround modes are as follows:

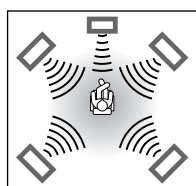

- 5 channels
(Front, center, and surround speakers are connected.)

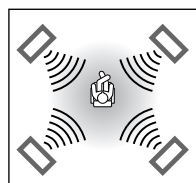

- 4 channels
(Front and surround speakers are connected.)

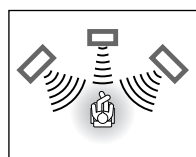

- 3 channels
(Front and center speakers are connected.)

■ Operating procedure

1 Select the source you want to listen to and start playing.

- When playing back software encoded with Dolby Digital and DTS Digital Surround, select the digital input mode (see page 15).

2 Press SURROUND.

The appropriate Surround mode will be activated according to the incoming signal.

- **DOLBY DIGITAL:**
Activated if you are playing back multi-channel software encoded with Dolby Digital.
- **DTS SURROUND:**
Activated if you are playing back software encoded with DTS Digital Surround.
- **PLII MUSIC* or PLII MOVIE:**
Activated if you are playing back any software other than the above. (The last one selected will be activated.)
The **PRO LOGIC II** indicator lights up on the display.
Press SURROUND repeatedly to select the one appropriate for the source.

* When "PLII MUSIC" is selected, you can select Panorama control to enjoy "wraparound" sound effect with side-wall image (see pages 17 and 18 for the setting procedure).

Notes:

- When "DOLBY DIGITAL" or "DTS SURROUND" is selected with no surround speakers connected, the surround sounds are downmixed and output from the front speakers.
- For the available Surround modes according to the input signals, see "Available Surround/DSP modes for each input signal" on page 23.

To adjust the speaker output level and select Panorama control for Pro Logic II Music, see pages 17 to 19. The adjustment is memorized for each source (except for Panorama control).

To turn off Surround mode, press SURROUND/DSP OFF.

Creating Realistic Sound Fields

Using DSP Modes

Speaker layouts required for the DSP modes are as follows:

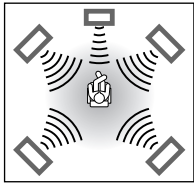

- 5 channels (Front, center, and surround speakers are connected.)

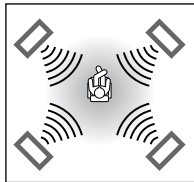

- 4 channels (Front and surround speakers are connected.)

Operating procedure

1 Start playing 2 channel software—either analog or Linear PCM—and select the source.

2 Press DSP.

The last selected DSP mode will be activated and the DSP indicator lights up on the display.

- Each time you press the button, the DSP mode changes as follows:

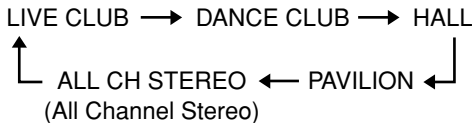

Note:

For the available DSP modes according to input signals, see “Available Surround/DSP modes for each input signal” on page 23.

To adjust the speaker output level and the effect level for DAP mode, see pages 17 to 19.

The adjustment is memorized for each source (except for the effect level).

To turn off DSP mode, press SURROUND/DSP OFF.

Adjustable items and selected Surround/DSP mode

- For adjustment operation, see pages 17 to 19.

Selected Surround/DSP mode	Adjustable items	Adjustable range
SURROUND OFF (stereo)	FRONT L LEVEL FRONT R LEVEL SUBWFR LEVEL	-10 to +10
DOLBY DIGITAL, DTS SURROUND, PLII MOVIE	FRONT L LEVEL FRONT R LEVEL CENTER LEVEL SURR L LEVEL SURR R LEVEL SUBWFR LEVEL	-10 to +10
PLII MUSIC	FRONT L LEVEL FRONT R LEVEL CENTER LEVEL SURR L LEVEL SURR R LEVEL SUBWFR LEVEL	-10 to +10
	PANORAMA CTRL	ON ⇌ OFF
LIVE CLUB, DANCE CLUB, HALL, PAVILION	FRONT L LEVEL FRONT R LEVEL SURR L LEVEL SURR R LEVEL SUBWFR LEVEL	-10 to +10
	EFFECT	1 to 5
ALL CH STEREO (All Channel Stereo)	FRONT L LEVEL FRONT R LEVEL CENTER LEVEL SURR L LEVEL SURR R LEVEL SUBWFR LEVEL	-10 to +10

Notes:

- Regardless of the selected Surround/DSP mode,
 - You cannot adjust the center speaker output level when the center speaker size is set to “NONE” (see page 13).
 - You cannot adjust the surround speaker output levels when the surround speaker size is set to “NONE” (see page 13).
- You cannot adjust the subwoofer output level when “SUBWOOFER NO” is selected for the subwoofer setting (see page 13).

Signal and speaker indicators on the display

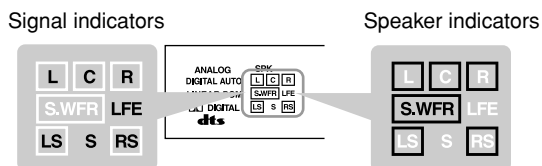

The following signal indicators light up—:

- L:
 - When digital input is selected: Lights up when the left channel signal comes in.
 - When analog input is selected: Always lights up.
- R:
 - When digital input is selected: Lights up when the right channel signal comes in.
 - When analog input is selected: Always lights up.
- C: When the center channel signal comes in.

- LS: When the left surround channel signal comes in.
- RS: When the right surround channel signal comes in.
- S: When the monaural surround channel signal comes in.
- LFE: When the LFE channel signal comes in.

The speaker indicators light up when the corresponding speaker is connected and activated.

Note:

When “SUBWOOFER YES” is selected for the subwoofer setting (see page 13) and the subwoofer output is turned on (see page 16), **S.WFR** lights up.

COMPU LINK Remote Control System

The COMPU LINK remote control system allows you to operate JVC's audio components through the remote sensor on the receiver.

To use this remote control system, you need to connect JVC's audio components through the COMPU LINK (SYNCHRO) jacks (see below) in addition to the connections using cables with RCA pin plugs (see page 7).

- Make sure that the AC power cords of these components are unplugged before connection. Plug in the AC power cords only after all other connections are completed.

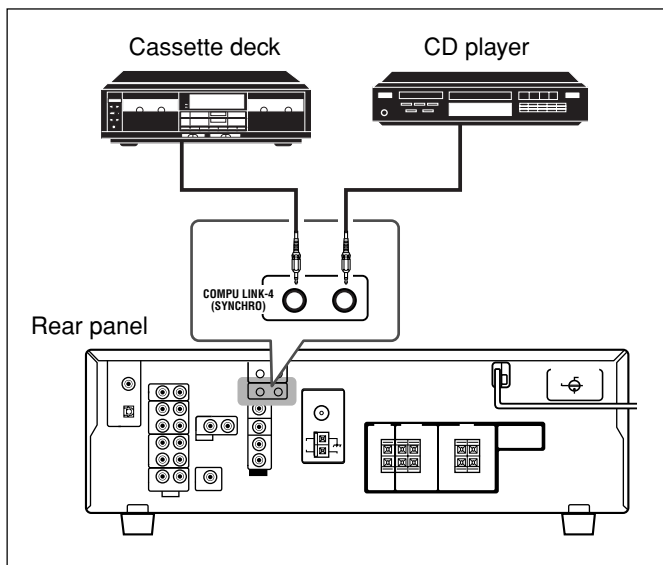

Notes:

- There are four versions of the COMPU LINK remote control system. This receiver is equipped with the fourth version—COMPU LINK-4. This version adds systematic operations with the CD recorder to the previous version—COMPU LINK-3.
- If your audio component has two COMPU LINK jacks, you can use either one. If it has only one COMPU LINK jack, connect it so that it is the last item in the series of components.
- To operate the cassette deck or CD recorder using the COMPU LINK remote control system, set the source name correctly. (See page 10.)
- Refer also to the manuals supplied with your audio components.

This remote control system allows you to use the four functions listed below.

Remote Control through the Remote Sensor on the Receiver

You can control the connected audio components through the remote sensor on the receiver using this remote control. Aim the remote control directly at the remote sensor on the receiver. For details, see pages 29 and 30.

Automatic Source Selection

When you press the play (▶) button on a connected component or on its own remote control, the receiver automatically turns on and changes the source to the component. On the other hand, if you select a new source on the receiver or on the remote control, the selected component begins playing immediately. In both cases, the previously selected source continues playing without sound for a few seconds.

Automatic Power On/Off (Standby): only possible with the COMPU LINK-3 and COMPU LINK-4

Both the CD player and cassette deck (or CD recorder) turn on and off (standby) along with the receiver. When you turn on the receiver, the CD player or cassette deck (or CD recorder) will turn on automatically, depending on which component has been previously selected. When you turn off the receiver, both the CD player and cassette deck (or CD recorder) will turn off (standby).

Synchronized Recording

Synchronized recording means the cassette deck starts recording as soon as a CD begins playing.

To use synchronized recording, follow these steps:

- 1 Put a tape in the cassette deck and a disc in the CD player.**
- 2 Press the record (●) button and the pause (⏸) button on the cassette deck at the same time.**

This puts the cassette deck into recording pause. If you do not press the record (●) button and pause (⏸) button at the same time, the synchronized recording feature will not operate.
- 3 Press the play (▶) button on the CD player.**

The source changes on the receiver, and as soon as play starts, the cassette deck starts recording. When the play ends, the cassette deck enters recording pause, and stops about 4 seconds later.

Notes:

- During synchronized recording, the selected source cannot be changed.
- If the power of any component is shut off during synchronized recording, the COMPU LINK remote control system may not operate properly. In this case, you must start again from the beginning.

AV COMPU LINK Remote Control System

The AV COMPU LINK remote control system allows you to operate JVC's video components (TV, VCR, and DVD player) through the receiver.

To use this remote control system, you need to connect the video components you want to operate following the diagrams and the procedure below.

■ AV COMPU LINK connection

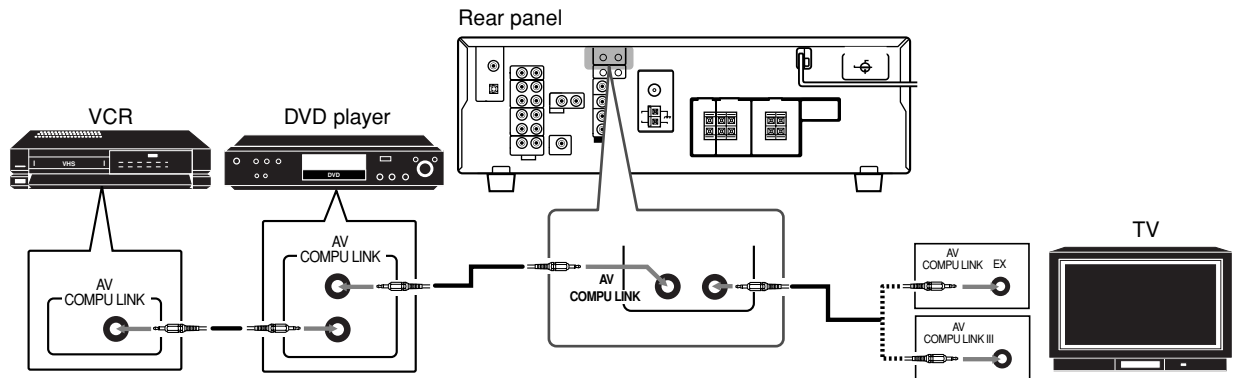

Note:

You can connect to the TV with the AV COMPU LINK EX or AV COMPU LINK III terminal.
A TV with AV COMPU LINK RECEIVER/AMP terminal can not be used.

■ Video cable connection

Connect the DVD player and/or the VCR to this receiver using the VIDEO (composite video) terminals, and connect this receiver to the TV's Video Input 2 terminals (composite video input) using composite video cables.

Notes:

- When connecting only the VCR or DVD player to this receiver, connect it directly to the receiver using cables with the monaural mini-plugs.
- Make sure that the remote control code of the VCR connected to the VCR jacks is set to code "A."
- Refer also to the manuals supplied with your video components.

■ Connecting procedure

- 1** If you have already plugged your VCR, DVD player, TV and this receiver into the AC outlets, unplug their AC power cords first.
- 2** Connect your VCR, DVD player, TV and this receiver as illustrated above, using the cables with monaural mini-plugs (not supplied).
- 3** Connect the audio/video input/output jacks on VCR, DVD player, TV and this receiver (see page 8).

4 Plug the AC power cords of the components into the AC outlets.

5 When turning on the TV for the first time after the AV COMPU LINK connection, turn the TV volume to the minimum using the TV volume control on the TV.

6 Turn on the other connected components first, then turn on this receiver.

- When turning on the VCR, use the remote control supplied with this receiver (press STANDBY/ON \odot /VCR).

The AV COMPU LINK remote control system allows you to use the five basic functions listed below.

Remote Control of the TV, DVD player, and VCR using this Remote Control

See page 31 for details.

- Aim the remote control directly at the remote sensor on each target component.

One-Touch Video Play

Simply by inserting a video cassette without its safety tab into the VCR, you can start video playback without setting other switches manually. The receiver automatically turns on and changes the source to "VCR."

The TV automatically turns on and changes the input mode to the position so that you can view the playback.

When you insert a video cassette with its safety tab, press the play (▶) button on the VCR or on the remote control to get the same result.

One-Touch DVD Play

Simply by starting playback on the DVD player, you can view the DVD playback without setting other switches manually.

- When the DVD player is connected through the analog input jacks on this receiver (and analog input is selected), the receiver automatically turns on and changes the source to "DVD."
- When the DVD player is connected through the digital input terminal on this receiver (and digital input is selected), the receiver automatically turns on and changes the source to "DVD DIGITAL."
- The TV automatically turns on and changes the input mode to the appropriate position so that you can view the playback.

Automatic Selection of the TV Input Mode

- When you select "TV SOUND" as the source to play on the receiver, the TV automatically changes the input mode to the TV tuner so that you can watch TV.
- When you select "DVD" or "VCR" as the source to play on the receiver, the TV automatically changes the input mode to the appropriate position so that you can view the playback.

Automatic Power On/Off

The TV, VCR, and DVD player turn on and off along with the receiver.

When you turn on the receiver;

- If the previously selected source is "VCR," the TV and VCR will turn on automatically.
- If the previously selected source is "TV SOUND," only the TV will turn on automatically.
- If the previously selected source is "DVD," the TV and DVD player will turn on automatically.

When you turn off the receiver, the TV, VCR, and DVD player will turn off.

Note:

If you turn off the receiver while recording on the VCR, the VCR will not turn off, but continue recording.

Operating JVC's Audio/Video Components

You can use the remote control to operate other JVC components.

Operating Audio Components

IMPORTANT:

To operate JVC's audio components using this remote control:

- You need to connect JVC's audio components through the COMPU LINK (SYNCHRO) jacks (see page 26) in addition to the connections using cables with RCA pin plugs (see page 7).
- Aim the remote control directly at the remote sensor on the receiver.
- If you use the buttons on the front panel, the remote control will not operate that source. To operate a source with the remote control, the source must be selected using source selection buttons on the remote control.
- To operate the cassette deck or CD recorder using the COMPU LINK remote control system, set the source name correctly. (See page 10.)
- Refer also to the manuals supplied with your audio components.

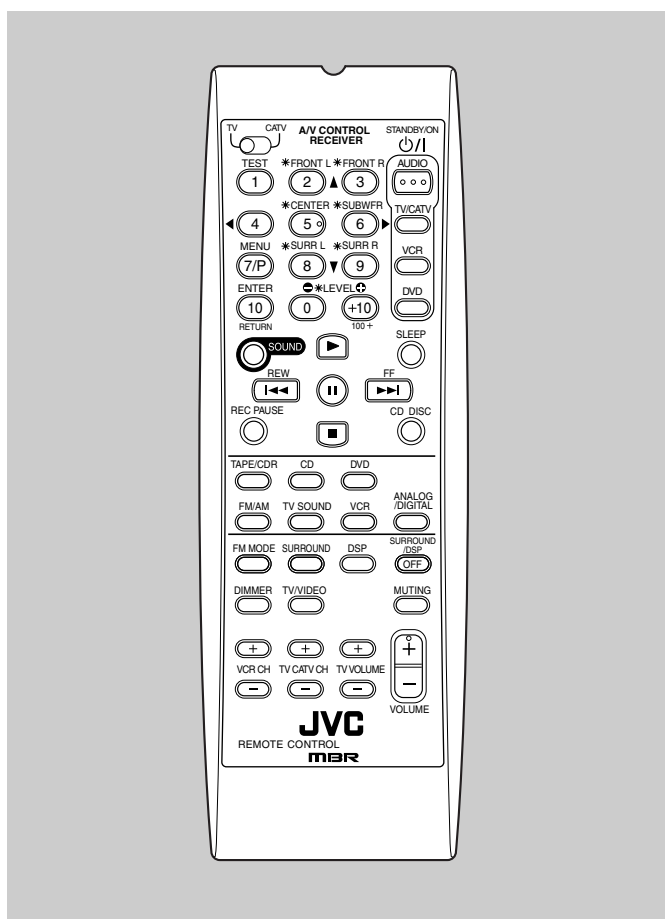

Sound Adjustment

You can always use the following buttons:

SURROUND	Turn on and select the Surround modes.
DSP	Turn on and select the DSP modes.
SURROUND/DSP OFF	Turn off the Surround or DSP modes.

After pressing SOUND, you can use the following buttons for the sound adjustment:

SUBWFR → LEVEL \oplus/\ominus	Adjust the subwoofer output level.
FRONT L → LEVEL \oplus/\ominus	Adjust the left front speaker output level.
FRONT R → LEVEL \oplus/\ominus	Adjust the right front speaker output level.
CENTER → LEVEL \oplus/\ominus	Adjust the center speaker output level.
SURR L → LEVEL \oplus/\ominus	Adjust the left surround speaker output level.
SURR R → LEVEL \oplus/\ominus	Adjust the right surround speaker output level.
TEST	Turn on or off the test tone output.

Note:

When you use the 10 keys to operate your target source after sound adjustments, press the source selection button first so that the 10 keys work for the target source.

Tuner

You can always use the following buttons:

FM/AM	Alternate between FM and AM.
1 – 10, +10	Select a preset channel number directly. <ul style="list-style-type: none"> • For channel number 5, press 5. • For channel number 15, press +10, then 5. • For channel number 20, press +10, then 10.
FM MODE	Change the FM reception mode.

CD player

After pressing CD, you can use the following buttons for the CD operations:

▶	Start playback.
◀◀	Return to the beginning of the current (or previous) tracks.
▶▶	Skip to the beginning of the next tracks.
■	Stop playback.
	Pause playback. To release, press ▶.
1 – 10, +10	Select a track number directly. <ul style="list-style-type: none">• For track number 5, press 5.• For track number 15, press +10, then 5.• For track number 20, press +10, then 10.

CD changer

After pressing CD-DISC, you can use the following buttons for the CD changer operations:

▶	Start playback.
◀◀	Return to the beginning of the current (or previous) tracks.
▶▶	Skip to the beginning of the next tracks.
■	Stop playback.
	Pause playback. To release, press ▶.
1 – 6, 7/P	Select the number of a disc installed in a CD changer.

After pressing CD, you can use the following buttons for the CD changer operations:

1 – 10, +10	Select a track number directly. <ul style="list-style-type: none">• For track number 5, press 5.• For track number 15, press +10, then 5.• For track number 20, press +10, then 10.• For track number 30, press +10, +10, then 10.
-------------	---

Example:

Selecting disc number 4, track number 12, and starting playback.

- 1** Press CD-DISC, then press 4.
- 2** Press CD, then press +10, 2.

Cassette deck

After pressing TAPE/CDR, you can use the following buttons for the cassette deck operations:

▶	Start playback.
FF	Fast wind a tape from left to right.
REW	Fast wind a tape from right to left.
■	Stop playback or recording.
	Pause playback. To release, press ▶.
REC PAUSE	Press this button to enter recording pause. Press this button then ▶ to start recording.

Note:

Before starting the above operations, make sure that you have changed the source name correctly. See page 10.

CD recorder

After pressing TAPE/CDR, you can use the following buttons for the CD recorder operations:

▶	Start playback.
◀◀	Return to the beginning of the current (or previous) tracks.
▶▶	Skip to the beginning of the next tracks.
■	Stop playback.
	Pause playback. To release, press ▶.
REC PAUSE	Press this button to enter recording pause. Press this button then ▶ to start recording.

Note:

Before starting the above operations, make sure that you have changed the source name correctly. See page 10.

Operating JVC's Audio/Video Components

Operating Video Components

IMPORTANT:

To operate JVC's video components using this remote control:

- You need to connect JVC's video components through the AV COMPU LINK terminals (see page 27) in addition to the connections using cables with RCA pin plugs (see page 8).
- Some JVC VCRs can accept two types of control signals—remote code "A" and "B." Before using this remote control, make sure that the remote control code of the VCR connected to the VCR jacks is set to code "A."
- When using the remote control, aim the remote control directly at the remote sensor on each component, not on the receiver.

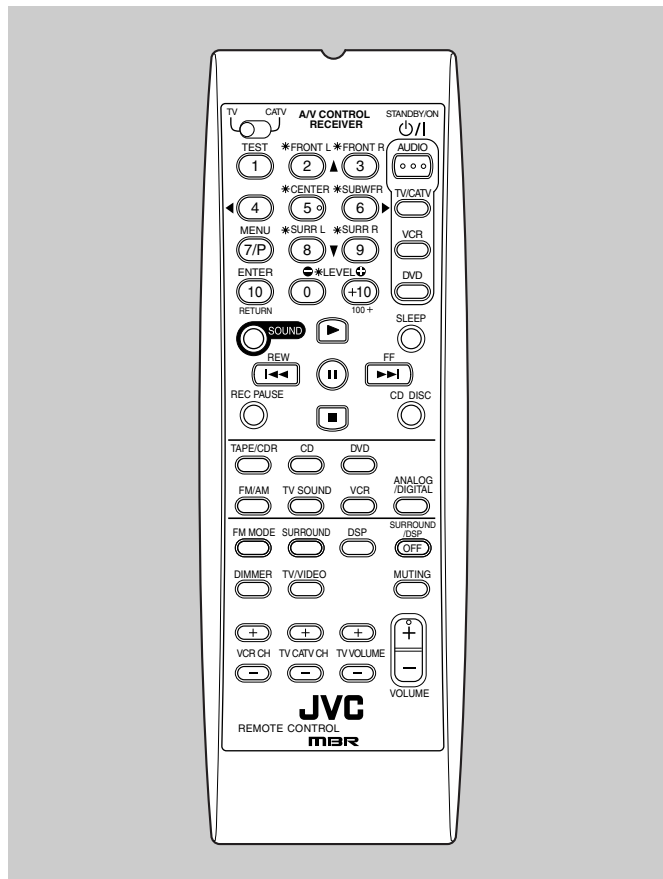

TV

You can always use the following buttons:

STANDBY/ON \odot/I TV/CATV	Turn on or off the TV.
TV/VIDEO	Change the input mode (TV tuner and video input).
TV VOLUME +/-	Adjust the volume.
TV/CATV CH +/-	Change the channels.

After pressing TV SOUND, you can use the following buttons for the TV and CATV operations:

1 - 9, 0, +10 (100+)	Select a channel.
RETURN (10)	Function as the RETURN button.

VCR

You can always use the following buttons:

STANDBY/ON \odot/I VCR	Turn on or off the VCR.
VCR CH +/-	Change the TV channels on the VCR.

After pressing VCR, you can use the following buttons for the VCR operations:

▶	Start playback.
FF	Fast wind a tape.
REW	Rewind a tape.
■	Stop playback or recording.
 	Pause playback. To release, press ▶ .
1 - 9, 0	Select a TV channel on the VCR.
REC PAUSE	Press this button to enter recording pause. Press this button then ▶ to start recording.

DVD player

You can always use the following buttons:

STANDBY/ON \odot/I DVD	Turn on or off the DVD player.
---	--------------------------------

After pressing DVD, you can use the following buttons for the DVD operations:

▶	Start playback.
◀◀	Return to the beginning of the current (or previous) chapters.
▶▶	Skip to the beginning of the next chapters.
■	Stop playback.
 	Pause playback. To release, press ▶ .

DVD menu operations

After pressing DVD, you can use the following buttons for DVD menu operations:

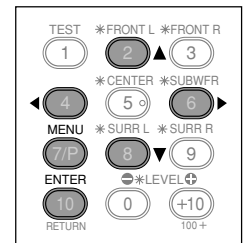

MENU	Display or hide the menu screen.
▲/▼/▶/◀	Select an item on the menu screen.
ENTER (10)	Enter a selected item.

Operating Other Manufacturers' Video Equipment

By changing the transmission signals, you can use the remote control supplied for this unit to operate other manufacturers' equipment.

- Refer also to the manuals supplied for the other products.
- To operate these components with the remote control, first you need to set the manufacturers' code each for TV, CATV converter, VCR and DVD player.
- When replacing the batteries in the remote control, set the manufacturers' codes again.

To change the transmission signals for operating a TV

- 1 Set TV/CATV selector to "TV."
- 2 Press and hold **STANDBY/ON** ϕ /TV/CATV.
- 3 Press **TV SOUND**.
- 4 Enter manufacturer's codes using buttons 1 – 9, and 0.
- 5 Release **STANDBY/ON** ϕ /TV/CATV.

Now, you can perform the following operations on the TV.

STANDBY/ON ϕ /TV/CATV	Turn on or off the TV.
TV/VIDEO	Set the input mode (either TV or VIDEO).
TV VOLUME +/-	Adjust the volume.
TV/CATV CH +/-	Change the channels.

After pressing TV SOUND, you can perform the following operations on the TV:

1 – 9, 0, +10 (100+)	Select the channels.
ENTER (10)	Function as the ENTER button.

Note:

Refer also to the manual supplied with your TV.

- 6 Try to operate your TV by pressing **STANDBY/ON** ϕ /TV/CATV.

When your TV turns on or off, you have entered the correct codes.

If more than one code is listed for your brand of TV, try each one until the correct one is entered.

Manufacturers' codes for TV

Manufacturer	Codes
JVC	01*
Hitachi	10
Magnavox	02
Mitsubishi	03
Panasonic	04, 11
RCA	05
Samsung	12
Sanyo	13
Sharp	06
Sony	07
Toshiba	08
Zenith	09

* "01" is the initial setting.

To change the transmission signals for operating a CATV converter

- 1 Set TV/CATV selector to "CATV."
- 2 Press and hold **STANDBY/ON** ϕ /TV/CATV.
- 3 Press **TV SOUND**.
- 4 Enter manufacturer's codes using buttons 1 – 9, and 0.
- 5 Release **STANDBY/ON** ϕ /TV/CATV.

Now, you can perform the following operations on the CATV converter.

STANDBY/ON ϕ /TV/CATV	Turn on or off the CATV converter.
TV/CATV CH +/-	Change the channels.

After pressing TV SOUND, you can perform the following operations on the CATV converter:

1 – 9, 0, +10 (100+)	Select the channels.
ENTER (10)	Function as the ENTER button.

Note:

Refer also to the manual supplied with your CATV converter.

- 6 Try to operate your CATV converter by pressing **STANDBY/ON** ϕ /TV/CATV.

When your CATV converter turns on or off, you have entered the correct codes.

If more than one code is listed for your brand of CATV converter, try each one until the correct one is entered.

Manufacturers' codes for CATV converter

Manufacturer	Codes
Echostar	01*
General Instrument	02, 03, 04, 05, 06, 07, 08, 09
Hamlin	16, 17, 18, 19
Pioneer	14, 15
RCA	20
Scient	10, 11
Sony	21
Zenith	12, 13

* "01" is the initial setting.

Manufacturers' codes are subject to change without notice. If they are changed, this remote control cannot operate the equipment.

Operating Other Manufacturers' Video Equipment

To change the transmission signals for operating a VCR

- 1 Press and hold **STANDBY/ON** ϕ /I VCR.
- 2 Press **VCR**.
- 3 Enter manufacturer's codes using buttons 1 – 9, and 0.
- 4 Release **STANDBY/ON** ϕ /I VCR.

Now, you can perform the following operations on the VCR.

STANDBY/ON ϕ /I VCR	Turn on or off the VCR.
VCR CH +/-	Change the channels.

After pressing VCR, you can perform the following operations on the VCR:

\blacktriangleright	Start playback.
FF	Fastwind a tape.
REW	Rewind a tape.
\blacksquare	Stop playback or recording.
II	Pause playback. To release, press \blacktriangleright .
REC PAUSE	Press this button to enter recording pause. Then press \blacktriangleright to start recording.

Note:

Refer also to the manual supplied with your VCR.

5 Try to operate your VCR by pressing **STANDBY/ON** ϕ /I VCR.

When your VCR turns on or off, you have entered the correct codes.

If more than one code is listed for your brand of VCR, try each one until the correct one is entered.

Manufacturers' codes for VCR

Manufacturer	Codes
JVC	01*, 02, 03
Emerson	10, 22
Gold Star	11
Hitachi	04
Mitsubishi	12
NEC	21
Panasonic	07, 13
Philips	09
RCA	05, 06
Samsung	20
Sanyo	17, 18, 19
Sony	14, 15, 16
Zenith	08

* "01" is the initial setting.

To change the transmission signals for operating a DVD player

- 1 Press and hold **STANDBY/ON** ϕ /I DVD.
- 2 Press **DVD**.
- 3 Enter manufacturer's codes using buttons 1 – 9, and 0.
- 4 Release **STANDBY/ON** ϕ /I DVD.

Now, you can use the following buttons on the DVD player.

\blacktriangleright	Start playback.
\blacksquare	Stop playback.
$\blacktriangleright\blacktriangleright$	Skip to the beginning of the next chapters.
$\blacktriangleleft\blacktriangleleft$	Return to the beginning of the current (or previous) chapters.
II	Pause playback. To release, press \blacktriangleright .

DVD menu operations

After pressing DVD, you can use the following buttons for DVD menu operations:

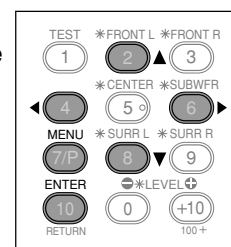

MENU	Display or hide the menu screen.
$\blacktriangle/\blacktriangledown/\blacktriangleright/\blacktriangleleft$	Select an item on the menu screen.
ENTER (10)	Enter a selected item.

5 Try to operate your DVD player by pressing **STANDBY/ON** ϕ /I DVD.

When your DVD player turns on or off, you have entered the correct codes.

Manufacturers' codes for DVD player

Manufacturer	Codes
JVC	01*
Panasonic	02
Philips	04
Pioneer	03
Sony	05
Toshiba	06
Yamaha	07

* "01" is the initial setting.

Manufacturers' codes are subject to change without notice. If they are changed, this remote control cannot operate the equipment.

Troubleshooting

Use this chart to help you solve daily operational problems. If there is any problem you cannot solve, contact your JVC service center.

PROBLEM	POSSIBLE CAUSE	SOLUTION
The power does not come on.	The power cord is not plugged in.	Plug the power cord into an AC outlet.
No sound from speakers.	Speaker signal cables are not connected.	Check speaker wiring and reconnect if necessary.
	An incorrect source is selected.	Select the correct source.
	Muting is activated.	Press MUTING on the remote control to cancel the mute.
	An incorrect input mode (analog or digital) is selected.	Select the correct input mode (analog or digital).
	Connections are incorrect.	Check connections. For analog connections, see pages 7 and 8. For digital connections, see page 9.
Sounds from speakers are heard unequally.	Speaker signal cables are not connected properly.	Check speaker wiring and reconnect if necessary.
	The speaker output level is not set correctly.	Adjust the speaker output level (see pages 17 – 19).
No test tone is available.	The speakers are deactivated.	Press SPEAKERS ON/OFF on the front panel to activate the speakers (see page 12).
Continuous hiss or buzzing during FM reception.	Incoming signal is too weak.	Connect an outdoor FM antenna or contact your dealer.
	The station is too far away.	Select a new station.
	The wrong antenna is being used.	Check with your dealer to be sure you have the correct antenna.
	Antennas are not connected properly.	Check connections.
Occasional cracking noise during FM reception.	Ignition noise from automobiles.	Move the antenna farther from automobile traffic.
“OVERLOAD” starts flashing on the display.	Speakers are overloaded because of high volume.	<ol style="list-style-type: none"> 1. Press STANDBY/ON ϕ/I on the front panel to turn off the receiver. 2. Stop the playback source. 3. Turn on the receiver again, and adjust the volume.
	Speakers are overloaded because of short circuit of speaker terminals.	Press STANDBY/ON ϕ /I on the front panel, then check the speaker wiring. If “OVERLOAD” does not disappear after turning on the receiver again, unplug the AC power cord, then plug it back in again. If speaker wiring is not short-circuited, contact your dealer.
“DSP MICOM NG” starts flashing on the display.	The built-in microcomputer is not functioning correctly.	Press STANDBY/ON ϕ /I on the front panel to turn off the receiver. After unplugging the power cord, consult your dealer.
The STANDBY lamp lights up after turning on the power, but soon the receiver turns off (into standby mode).	The receiver is overloaded because of a high voltage.	Press STANDBY/ON ϕ /I on the front panel to turn off the receiver. After unplugging the power cord, consult your dealer.
Remote control does not work.	There is an obstruction in front of the remote sensor on the receiver.	Remove the obstruction.
	Batteries are weak.	Replace batteries in the remote control.
Remote control does not operate as you intend.	The remote control is not ready for your intended operation.	Press SOUND or source selection buttons first, then press the button you want to use. (See pages 18 and 29 – 31).

Amplifier

Output Power:	At Stereo operation:	
	Front channels:	100 W* per channel, min. RMS, driven into 8 Ω at 1 kHz with no more than 0.9% total harmonic distortion. (IEC268-3/DIN)
	At Surround operation:	
	Front channels:	100 W per channel, min. RMS, driven into 8 Ω at 1 kHz with no more than 0.8% total harmonic distortion.
	Center channel:	100 W, min. RMS, driven into 8 Ω at 1 kHz, with no more than 0.8% total harmonic distortion.
	Surround channels:	100 W per channel, min. RMS, driven into 8 Ω at 1 kHz, with no more than 0.8% total harmonic distortion.
	(* Measured on AC 110 V, 127 V, 220 V, and 240 V)	

Audio

Audio Input Sensitivity/Impedance (1 kHz):	CD, TAPE/CDR, VCR, TV SOUND, DVD:	220 mV/47 kΩ
Audio Input (DIGITAL IN)* :	Coaxial: DIGITAL 1 (DVD):	0.5 V (p-p)/75 Ω
	Optical: DIGITAL 2 (CD):	-21 dBm to -15 dBm (660 nm ±30 nm)
	* Corresponding to Linear PCM, Dolby Digital, and DTS Digital Surround (with sampling frequency—32 kHz, 44.1 kHz, 48 kHz).	
Audio Output Level:	TAPE/CDR, VCR:	220 mV
Signal-to-Noise Ratio ('66 IHF/DIN):	CD, TAPE/CDR, VCR, TV SOUND, DVD:	87 dB/67 dB
Frequency Response (8 Ω):	CD, TAPE/CDR, VCR, TV SOUND, DVD:	20 Hz to 20 kHz (±1 dB)
Tone Control:	Bass (100 Hz):	±10 dB
	Treble (10 kHz):	±10 dB

Video

Video Input Sensitivity/Impedance:		
Composite video:	DVD, VCR:	1 V (p-p)/75 Ω
Video Output Level/Impedance:		
Composite video:	VCR, MONITOR OUT:	1 V (p-p)/75 Ω
Synchronization:	Negative	
Signal-to-Noise Ratio:	45 dB	

FM tuner (IHF)

Tuning Range:	87.50 MHz to 108.00 MHz	
Usable Sensitivity:	Monaural:	17.0 dBf (1.95 μ V/75 Ω)
50 dB Quieting Sensitivity:	Monaural:	21.3 dBf (3.2 μ V/75 Ω)
	Stereo:	41.3 dBf (31.5 μ V/75 Ω)
Signal-to-Noise Ratio (IHF-A weighted):	Monaural:	78 dB at 85 dBf
	Stereo:	73 dB at 85 dBf
Total Harmonic Distortion:	Monaural:	0.4% at 1 kHz
	Stereo:	0.6% at 1 kHz
Stereo Separation at REC OUT:	35 dB at 1 kHz	
Alternate Channel Selectivity:	45 dB: (\pm 400 kHz)	
Frequency Response:	30 Hz to 15 kHz: (+0.5 dB, -3 dB)	

AM tuner

Tuning Range:	531 kHz to 1 602 kHz (at 9 kHz intervals)	
	530 kHz to 1 600 kHz (at 10 kHz intervals)	
Usable Sensitivity:	Loop antenna:	400 μ V/m
Signal-to-Noise Ratio:	50 dB (100 mV/m)	

General

Power Requirements:	AC 110 V/127 V/220 V/230 V – 240 V \sim , adjustable with the voltage selector, 50 Hz/60 Hz	
Power Consumption:	200 W (at operation)	
	2 W (in standby mode)	
Dimensions (W x H x D):	435 mm x 146.5 mm x 409.5 mm	
Mass:	8.8 kg	

Mains (AC) Line Instruction (not applicable for Europe, U.S.A., Canada, Australia and U.K.)

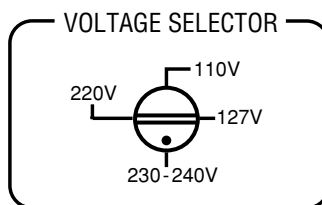
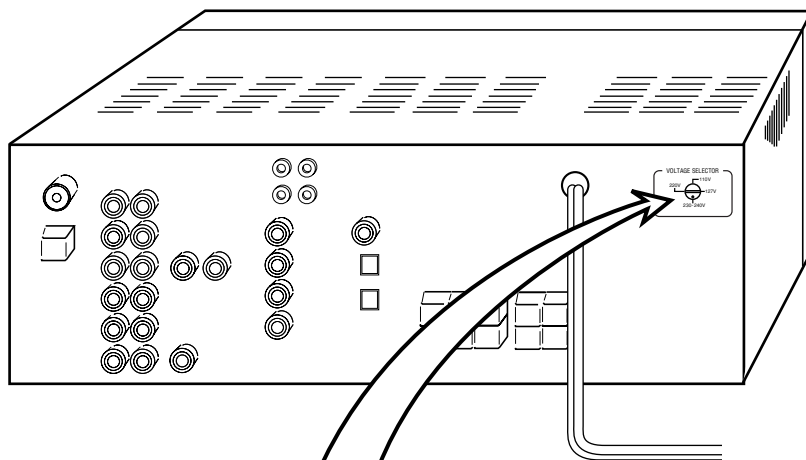

CAUTION for mains (AC) line

BEFORE PLUGGING IN, do check that your mains (AC) line voltage corresponds with the position of the voltage selector switch provided on the outside of this equipment and, if different, reset the voltage selector switch, to prevent from a damage or risk of fire/electric shock.

JVC

VICTOR COMPANY OF JAPAN, LIMITED